

User Manual

3/3 208V 10K(L)/15K(L)/20K(L)/30KL/40KL

3/3 208V 10K(L)/15K(L)/20K(L)/30KL/40KL DUAL

3/3 400V 10K(L)/15K(L)/20K(L)/30K(L)/40K(L)/60KL/80KL

3/3 400V 10K(L)/15K(L)/20K(L)/

30K(L)/40K(L)/60KL/80KL DUAL

PF 1 Online UPS

Uninterruptible Power Supply System



Please comply with all warnings and operating instructions in this manual. This equipment should only be installed, serviced, and maintained by qualified personnel. Do not operate this unit before reading through all safety information and operating instructions carefully.

Disclaimer

We assume no responsibility or liability for loss or damages, whether direct, indirect, consequential or incidental, which might arise out of the use of such information. The use of any such information will be entirely at the user's risk. Information in this manual is subject to change without notice. We make no commitment to update or keep current the information in this manual. If you find information in this manual that is incorrect, misleading, or incomplete, we would appreciate your comments and suggestions.

Table of Contents

1. SAFETY AND EMC INSTRUCTIONS	1
1-1. TRANSPORTATION AND STORAGE	1
1-2. PREPARATION	1
1-3. INSTALLATION	1
1-4.  CONNECTION WARNINGS	2
1-5. OPERATION	3
1-6. STANDARDS	3
2. INSTALLATION AND OPERATION	4
2-1. UNPACKING AND INSPECTION	4
2-2. WIRING TERMINAL VIEW	5
2-3. SINGLE UPS INSTALLATION	9
2-4. UPS INSTALLATION FOR PARALLEL SYSTEM	13
2-5. SOFTWARE INSTALLATION	15
3. OPERATIONS	16
3-1. BUTTON OPERATION	16
3-2. LED INDICATORS AND LCD PANEL	16
3-3. AUDIBLE ALARM	18
3-4. SINGLE UPS OPERATION	18
3-5. PARALLEL OPERATION	22
3-6. ABBREVIATION MEANING IN LCD DISPLAY	23
3-7. LCD SETTING	24
3-8. OPERATING MODE/STATUS DESCRIPTION	30
3-9. FAULT CODE	35
3-10. WARNING INDICATOR	36
3-11. WARNING CODE	36
4. TROUBLE SHOOTING	37
5. STORAGE AND MAINTENANCE	39
5-1. STORAGE	39
5-2. MAINTENANCE	39
6. SPECIFICATIONS	40

1. Safety and EMC instructions

All safety instructions in this document must be read, understood and followed.

1-1. Transportation and Storage



Please transport the UPS system only in the original packaging to protect against shock and damage.



The UPS must be stored in the room where the temperature is well regulated. Ambient temperature should not exceed 40°C.

1-2. Preparation



Condensation may form if the UPS system is moved immediately from cold to warm environment. The UPS system must be absolutely dry before being installed. Please allow at least two hours for the UPS system to acclimate the environment.



Do not install the UPS system near water or in moist environments.



Do not install the UPS system where it would be exposed to direct sunlight or nearby heat source.



Do not block ventilation holes on the UPS housing.

1-3. Installation



Do not connect appliances or devices which would overload the UPS (e.g. big motor-type equipment)) to the UPS output terminal.



Place cables in such a way that no one can step on or trip over them.



Do not block air vents on the housing of the UPS. Ensure proper unit spacing of ventilation.



UPS came equipped with grounding terminal, in the final installation phase, connect grounding/earthing wire to the external UPS battery cabinets or appropriate grounding terminals.



The UPS can be installed only by qualified maintenance personnel.



An appropriate disconnect device such as short-circuit backup protection should be incorporated during installation.



An integral emergency shutoff switch which prevents additional load from the UPS in any mode of operation should be implemented during the installation.



Secure the grounding/earthing wire before connecting to any live wire terminal.



Installation and Wiring must be in accordance with the local electrical laws and regulations.

1-4. Connection Warnings

- There is no standard backfeed protection inside of the UPS. However, there are relays on the Input to cut off line voltage and while the neutral is still connect to UPS.

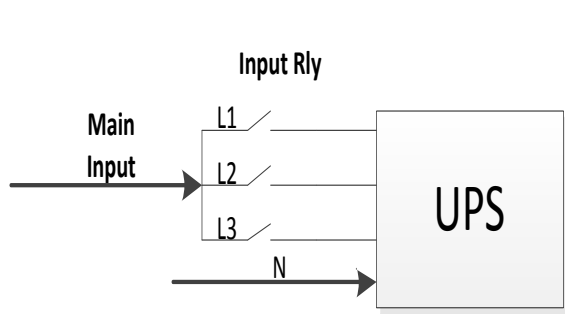

Input relay diagram

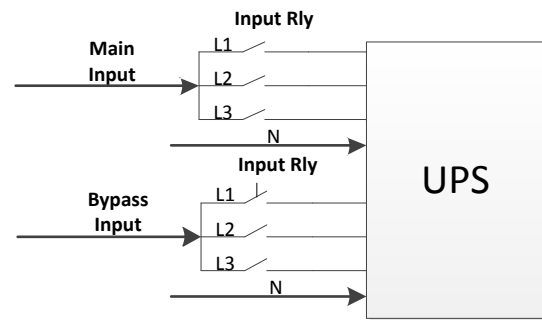

Input relay diagram for dual-input model

- This UPS should be connected with **TN** grounding/earthing system.
- The power input for this unit must be three-phase rated in accordance with the equipment nameplate. It also must be suitably grounded.

WARNING
HIGH LEAKAGE CURRENT
EARTH CONNECTION ESSENTIAL
BEFORE CONNECTING SUPPLY

- Use of this equipment in medical instrument of any life-sustaining equipment where failure of this equipment can reasonably be expected to cause the failure of the life-sustaining equipment or to significantly affect its safety or effectiveness is not recommended. Do not use this equipment in the presence of a flammable mixture with air, oxygen or nitrous oxide.
- Connect grounding terminal of UPS to a grounding electrode conductor.
- In accordance with safety standard EN-IEC 62040-1, installation has to be provided with a «Backfeed Protection» system, as for example a contactor, which will prevent the appearance of voltage or dangerous energy in the input mains during a mains fault (see figure 24 and respect the wiring diagram of «Backfeed Protection» depending if the equipment is with signal or three phase input).



There can be no derivation in the line that goes from the «Backfeed Protection» to the UPS, as the standard safety would be infringed.

- Warning labels should be placed on all primary power switches installed in places away from the unit to alert the electrical maintenance personnel of the presence of a UPS in the circuit. The label will bear the following or an equivalent text:

Before working on this circuit

- Isolate Uninterruptible Power Supply (UPS)
- Then check for Hazardous Voltage between all terminals including the protected earth

 **Risk of Voltage Backfeed**

1-5. Operation



Do not disconnect the grounding/earthing conductor cable on the UPS or the building wiring terminals under any circumstance.



The UPS system features its own, internal current source (batteries). The UPS output sockets or output terminal blocks may be electrically live even if the UPS system is not connected to the building mains/live wires. (only for standard models)



In order to fully disconnect the UPS system, first press the "OFF" button and then disconnect the mains/live wires.



Ensure that no liquid or other foreign objects can enter into the UPS system.



The UPS can be operated by any individuals with no previous experience.

1-6. Standards

* Safety	
IEC/EN 62040-1	
* EMI	
Conducted Emission.....:IEC/EN 62040-2	Category C3
Radiated Emission.....:IEC/EN 62040-2	Category C3
*EMS	
ESD.....:IEC/EN 61000-4-2	Level 4
RS..... :IEC/EN 61000-4-3	Level 3
EFT..... :IEC/EN 61000-4-4	Level 4
SURGE..... :IEC/EN 61000-4-5	Level 4
CS..... :IEC/EN 61000-4-6	Level 3
Power-frequency Magnetic field..... :IEC/EN 61000-4-8	Level 4
Low Frequency Signals.....:IEC/EN 61000-2-2	
Warning: This is a product for commercial and industrial application in the second environment-installation restrictions or additional measures may be needed to prevent disturbances.	

2. Installation and Operation

These series came with two VAC systems: 208V and 400V. There are two different types of models: standard and long-run models. Please refer to the following table.

VAC System	Model	Type	Model	Type
208V	LV 10K	Standard model	LV 10KL	Long-run model
	LV 10K DUAL		LV 10KL DUAL	
	LV 15K/20K		LV 15KL/ LV 20KL LV 15KL/LV 20KL DUAL	
	LV 15K/20K DUAL		LV 30KL/ LV 40KL LV 30KL/LV 40KL DUAL	
400V	HV 10K/15K/20K		HV 10KL/15KL/20KL	
	HV 10K/15K/20K DUAL		HV 10KL/15KL/20KL DUAL	
	HV 30K/40K		HV 30KL/HV 40KL HV 30KL/HV 40KL DUAL	
	HV 30K/40K DUAL		HV 60KL/ HV 80KL HV 60KL/HV 80KL DUAL	

We also offer optional parallel function for both models upon request. The UPS with parallel function is called the "Parallel model". We have detail installation and operation procedure of the Parallel Model in the following chapter.

2-1. Unpacking and Inspection

Unpack the package and check the package contents. The shipping package should contain:

- One UPS
- One user manual
- One monitoring software CD
- One RS-232 cable (option)
- One USB cable
- One parallel cable (only available for parallel model)
- One shared current cable (only available for parallel model)

NOTE: Before the installation, please inspect the unit. Be sure that there is no physical damage to the unit. Do not turn on the unit and notify the carrier and dealer immediately if there is any damage or missing parts and accessories. Please keep the original packaging for future use. It is recommended to keep each equipment and battery set in their original packaging because they have been designed to provide maximum protection during transportation and storage.

2-2. Wiring Terminal View

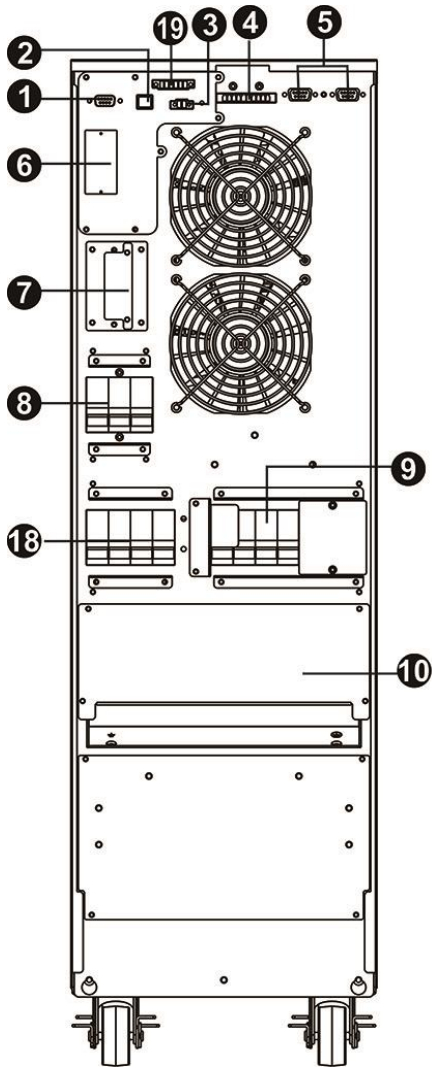

Diagram 1: LV10K(L)/HV 10K(L)/15K(L)/20K(L) Rear Panel

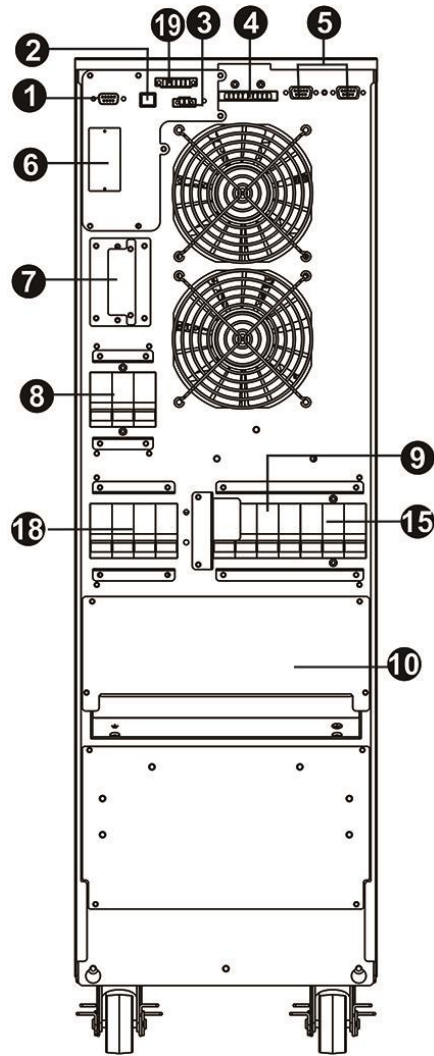

Diagram 2: LV 10K(L) DUAL/HV 10K(L) DUAL 15K(L) DUAL / 20K(L) DUAL Rear Panel

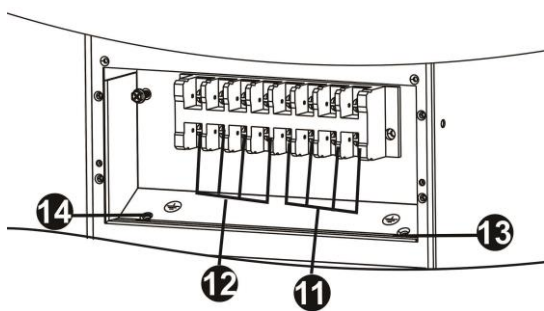

Diagram 3: LV10K(L)/HV 10K(L)/ 20K(L) Input/Output Terminal

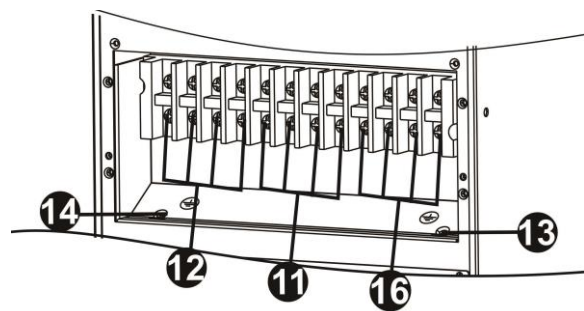

Diagram 4: LV 10K(L) DUAL/HV 10K(L) DUAL / 15K(L) DUAL / 20K(L) DUAL Input/Output Terminal

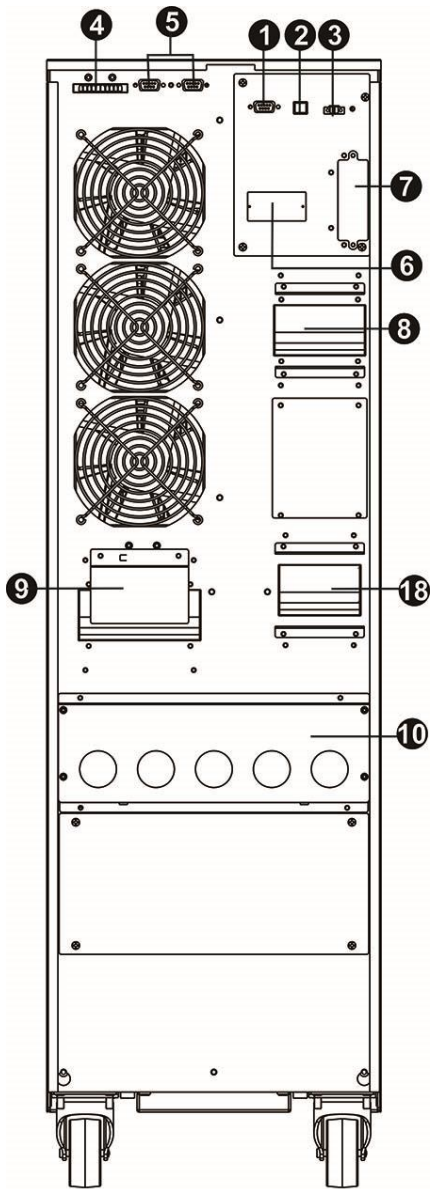

Diagram 5: HV 30K(L)/40K(L)/ LV 15K(L)/LV 20K(L) Rear Panel

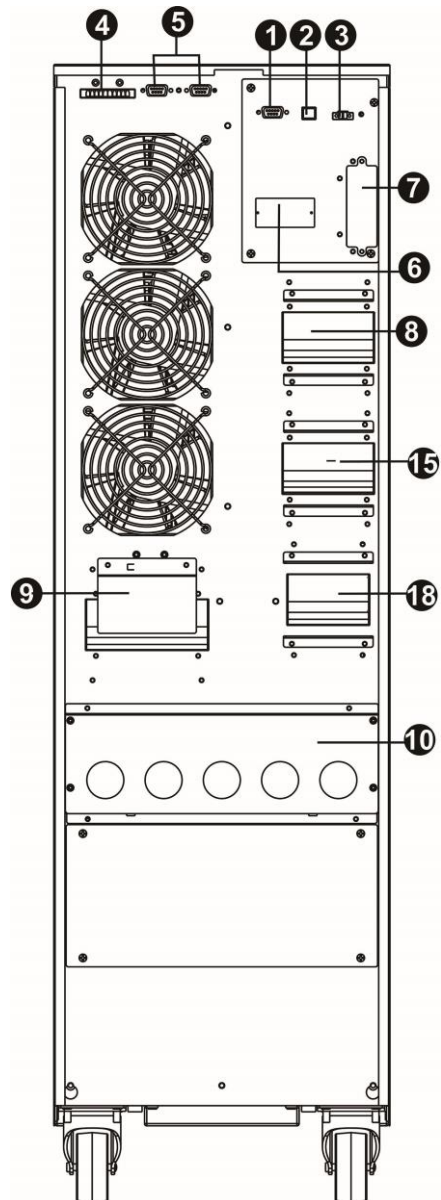

Diagram 6: HV 30K(L) DUAL/ 40K(L) DUAL/ LV 15K(L) DUAL/LV 20K(L) DUAL rear panel

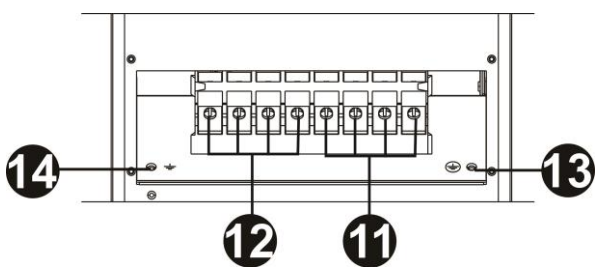

Diagram 7: HV 30K(L)/40K(L)/LV 15K(L) LV 20K(L) Input/output terminal

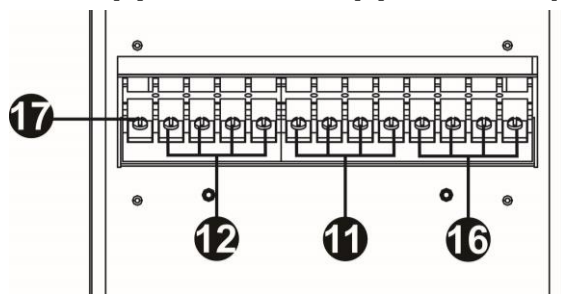
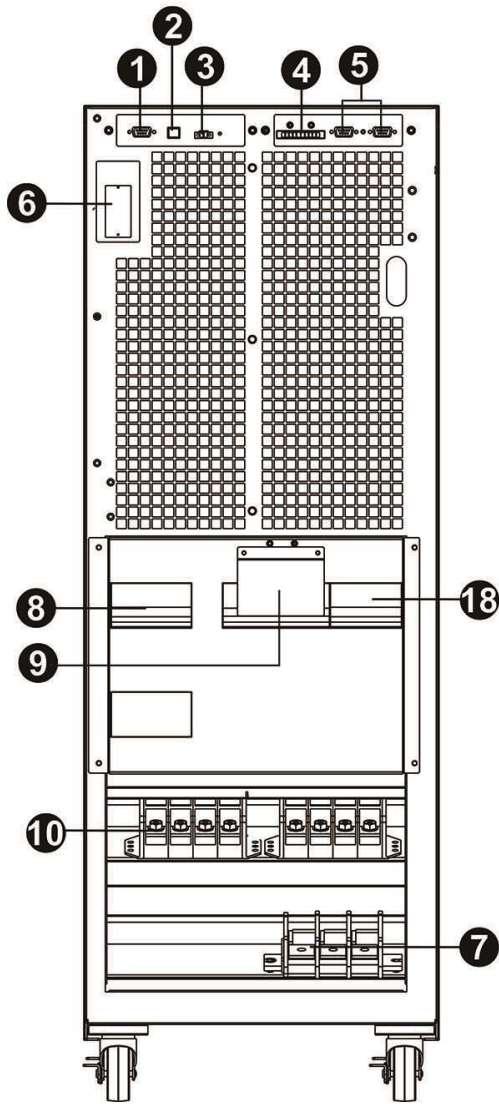
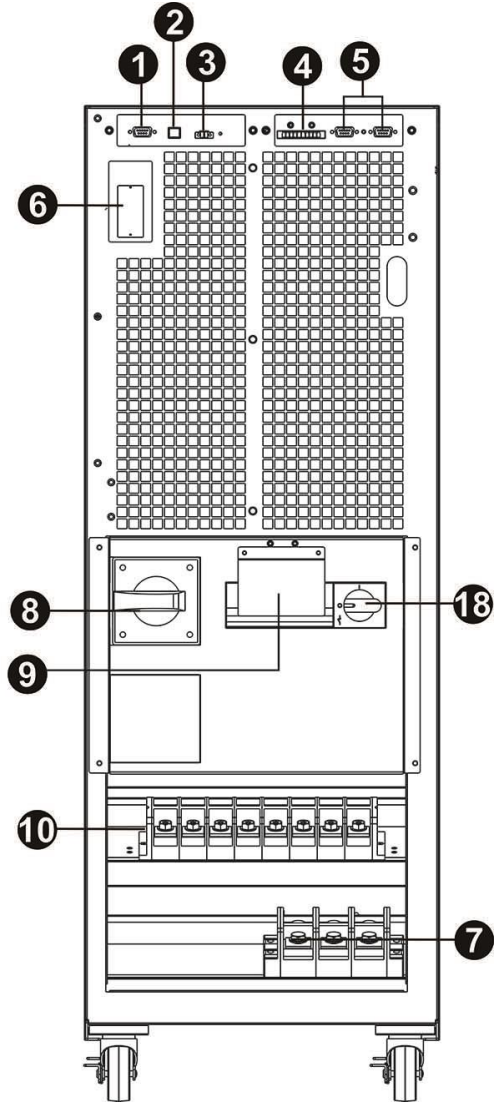

Diagram 8: HV 30K(L) DUAL / 40K(L) DUAL LV 15K(L) DUAL /LV 20K(L) DUAL Input /Output Terminal



**Diagram 9: HV 60KL/LV 30KL front view
with door open**



**Diagram 10: HV 80KL/LV 40KL front view
with door open**

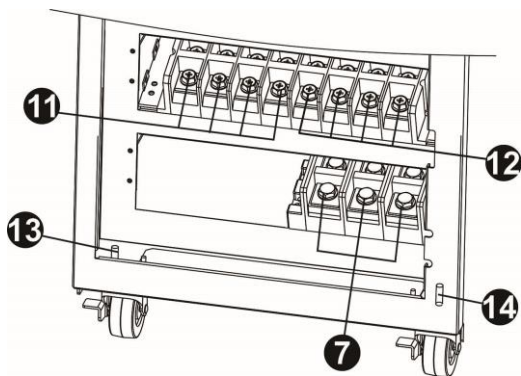

**Diagram 13: HV 60KL/HV 80KL/LV 30KL/LV 40KL
Input/Output Terminal**

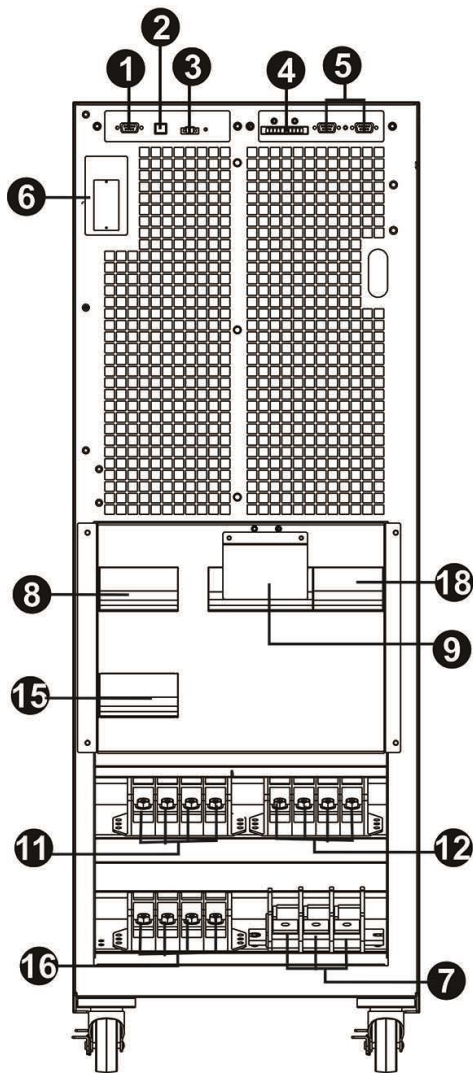

**Diagram 14: HV 60KL DUAL/LV 30KL DUAL
front view with door open**

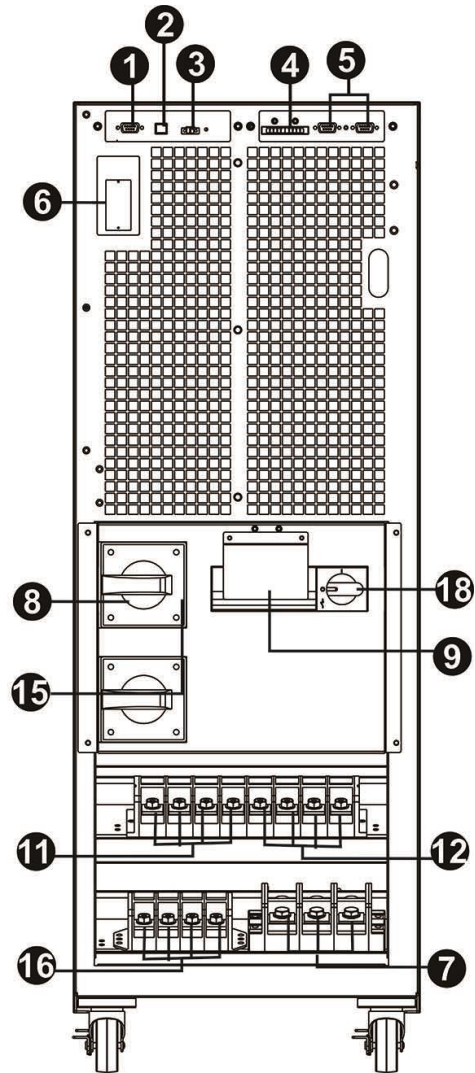

**Diagram 15: HV 80KL DUAL/LV 40KL DUAL
front view with door open**

1. RS-232 communication port
2. USB communication port
3. Emergency power off function connector (EPO connector)
4. Share current port (only available for parallel model)
5. Parallel port (only available for parallel model)
6. Intelligent slot
7. External battery connector/terminal (Only available for long-run model)
8. Line input circuit breaker/switch
9. Maintenance bypass switch (option)
10. Input/Output terminal (Refer to diagram 3, 4, 7, 8 and 13 for the details)
11. Line input terminal
12. Output terminal
13. Input grounding terminal
14. Output grounding terminal
15. Bypass input circuit breaker/switch
16. Bypass input terminal
17. Grounding terminal

- 18. Output switch
- 19. Dry contact communication port (optional)

2-3. Single UPS Installation

Installation and wiring must be carried out in accordance with the local electric laws and regulations by trained professionals.

1) Make sure that the mains wire and breakers of the building are rated for the capacity of the UPS to prevent electric shock or risk of fire.

NOTE: Do not use the wall receptacle as the input power source for the UPS, as its rated current is less than the UPS’s maximum input current. The receptacle may be damaged and destroyed.

- 2) Switch off the mains switch in the building before installation.
- 3) Turn off all the connected devices before connecting to the UPS.
- 4) Prepare wires based on the following table:

Model	Wiring spec (AWG)				
	Input(Ph)	Output(Ph)	Neutral	Battery	Ground
HV 10K / HV 10K DUAL	14	14	10		8
HV 10KL / HV 10KL DUAL	14	14	10	8	8
HV 15K / HV 15K DUAL	12	12	10		8
HV 15KL / HV 15KL DUAL	12	12	10	8	8
LV 10K/ LV 10K DUAL HV 20K/ HV 20K DUAL	10	10	6		6
LV 15K/LV 15K DUAL HV 30K/ HV 30K DUAL	8	8	4		4
LV 15KL / LV 15KL DUAL HV 30KL / HV 30KL DUAL	8	8	4	4	4
LV 20K / LV 20K DUAL HV 40K / HV 40K DUAL	6	6	4		4
LV 20KL / LV 20KL DUAL HV 40KL / HV 40KL DUAL	6	6	4	4	4
LV 30KL / LV 30KL DUAL HV 60KL / HV 60KL DUAL	4	4	1	1	4
LV 40KL / LV 40KL DUAL HV 80KL / HV 80KL DUAL	2	2	1/0	1/0	2

NOTE 1: The cable for HV 10K(L) and HV 10K(L) DUAL should be able to withstand over 20A current. It is recommended to use AWG 14 or thicker wire for Phase and AWG10 or thicker wire for Neutral for safety and efficiency.

NOTE 2: The cable for HV 15K(L) and HV 15K(L) DUAL should be able to withstand over 30A current. It is recommended to use AWG 12 or thicker wire for Phase and AWG10 or thicker wire for Neutral for safety and efficiency.

NOTE 3: The cable for HV 20K(L), HV 20K(L) DUAL, LV 10K(L) and LV 10K(L) DUAL should be able to withstand over 40A current. It is recommended to use AWG10 or thicker wire for Phase and AWG 6 or thicker wire for Neutral for safety and efficiency.

NOTE 4: The cable for HV 30K(L), HV 30K(L) DUAL, LV 15K(L) and LV 15K(L) DUAL should be able to withstand over 60A current. It is recommended to use AWG 8 or thicker wire for Phase and AWG 4 or thicker wire for Neutral for safety and efficiency.

NOTE 5: The cable for HV 40K(L), HV 40K(L) DUAL, LV 20K(L) and LV 20K(L) DUAL should be able to withstand over 80A current. It is recommended to use AWG 6 or thicker wire for Phase and AWG 4 or thicker wire for Neutral for safety and efficiency.

NOTE 6: The cable for HV 60KL, HV 60KL DUAL, LV 30KL and LV 30KL DUAL should be able to withstand over 120A current. It is recommended to use AWG 4 or thicker wire for Phase and AWG 1 or thicker wire for Neutral for safety and efficiency.

NOTE 7: The cable for HV 80KL, HV 80KL DUAL, LV 40KL and LV 40KL DUAL should be able to withstand over 160A current. It is recommended to use AWG 2 or thicker wire for Phase and AWG 1/0 or thicker wire for Neutral for safety and efficiency.

NOTE 8: The selections for color of wires should be followed by the local electrical laws and regulations.

5) Remove the terminal block cover at the rear panel of UPS. Then connect the wires according to the following terminal block diagrams: (Connect the grounding/earthing wire first when making other wire connections. Remove the grounding/earthing wire last when connecting the UPS!)

NOTE: For dual input model with single input power system, connect input terminals to the AC power source and connect input and bypass input together (shows dashed line in below wiring diagrams)

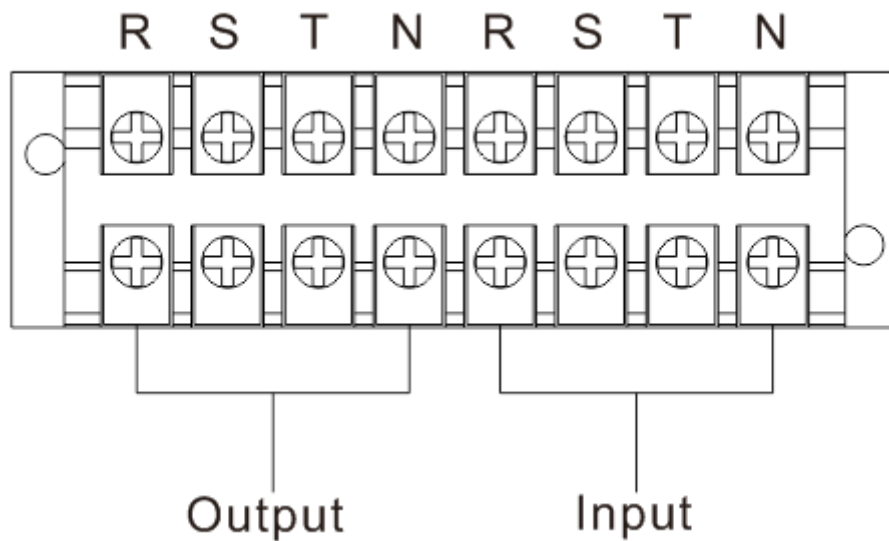

Terminal block wiring diagram for HV10K(L)/15K(L)/20K(L) and LV 10K(L)

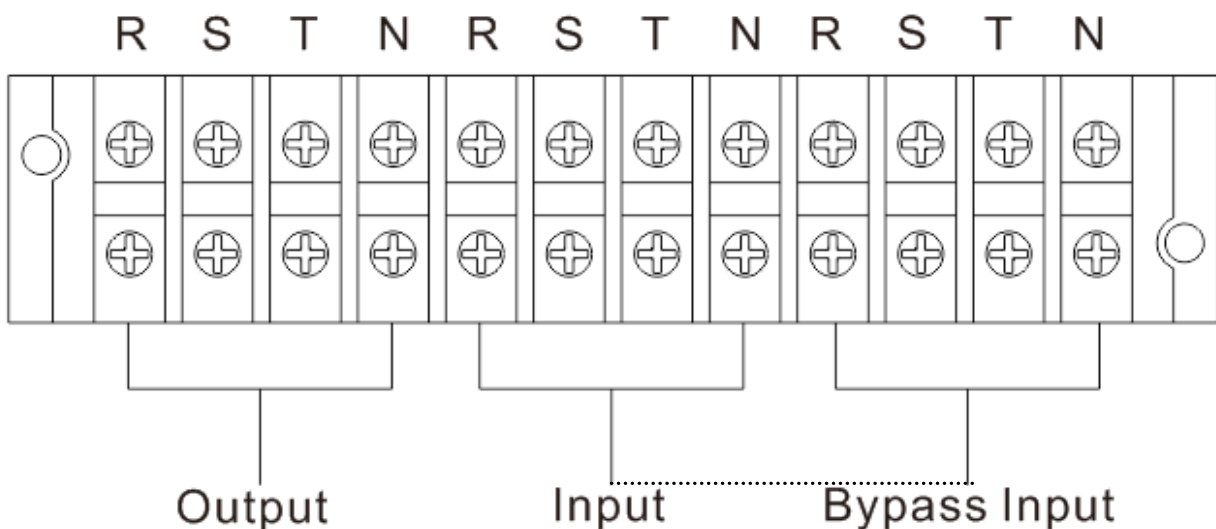

Terminal block wiring diagram for HV10K(L)/15(L)/20K(L) DUAL and LV 10K(L) DUAL

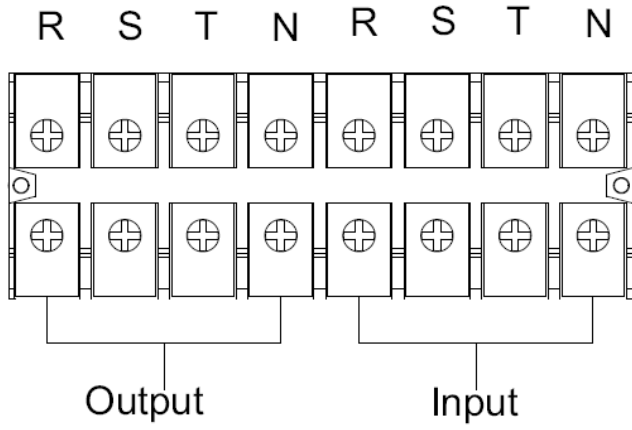

Terminal block wiring diagram for HV 30K(L)/40K(L) and LV 15K(L)/20K(L)

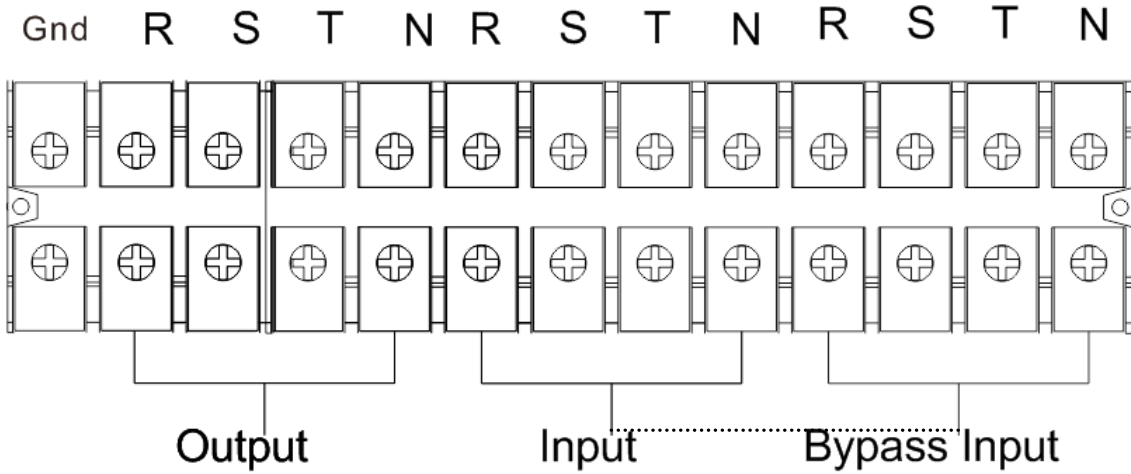

Terminal block wiring diagram for HV 30K(L) /40K(L) DUAL and LV 15K(L) DUAL/20K(L) DUAL

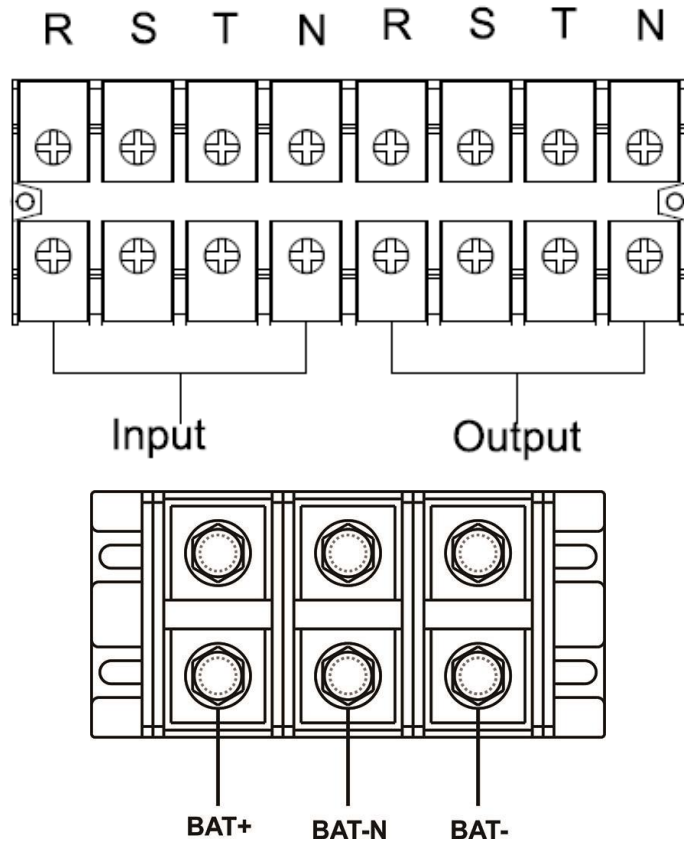

Terminal block wiring diagram for HV 60KL/80KL and LV 30KL/40KL

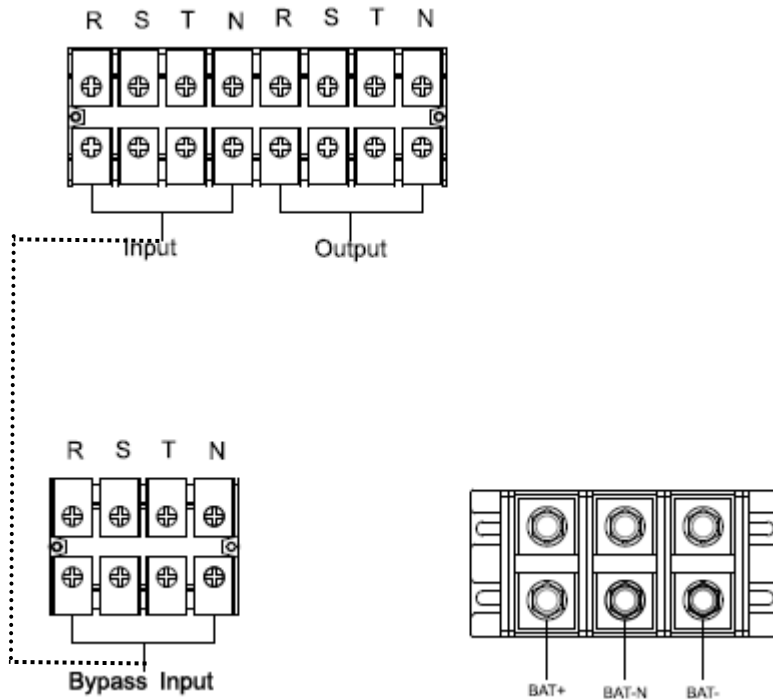

Terminal block wiring diagram for HV 60KL DUAL / 80KL DUAL and LV 30KL DUAL/40KL DUAL

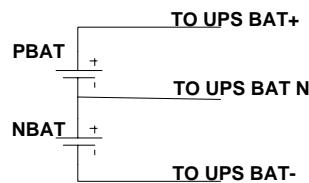

Battery wires connection schematic

NOTE 1: Make sure that the wires are connected securely with the terminals.

NOTE 2: Please install the output breaker between the output terminal and the load, and the breaker should have leakage current protective function if necessary.

6) Put the terminal block cover back at the rear panel of the UPS.



Warning: (Only for standard model)

- Make sure the UPS is off before the installation. The UPS should not be turned on during wiring connection.
- Do not attempt to modify the standard model into the long-run model. In particular, do not try to connect the standard internal battery to the external battery. The battery type and voltage may be different, risk of electric shock or fire may occurred!



Warning: (Only for long-run model)

- Make sure a DC breaker or other protective device between UPS and the external battery pack is installed for added safety. If not, please install it carefully. Switch off the battery breaker before installation.

NOTE: Set the battery pack breaker in "OFF" position and then install the battery pack.

- Pay special attention to the rated battery voltage marked on the rear panel. If you want to change the

numbers of the battery in a chain, make sure you modify the UPS setting accordingly. Connection with wrong battery voltage may cause irreversible damage of the UPS.

- Pay special attention to the polarity marking on external battery terminal block. Connection with wrong battery voltage may cause irreversible damage of the UPS.
- Make sure the protective grounding/earthing wiring is adequate. The current spec, color, position, connection and conductance reliability of the wire should be verified.
- Make sure the utility input & output wiring is rated correctly. The current spec, color, position, connection and conductance reliability of the wire should be verified. Make sure the L/N side is correct, not reverse or short-circuited.

2-4. UPS Installation for Parallel System

If the UPS is only for single operation, you may skip this section.

- 1) Install and wired the UPS according to the section 2-3.
- 2) Connect the output wires of each UPS to an output breaker.
- 3) Connect all output breakers to a major breaker. This major output breaker will then connect directly to the loads.
- 4) Either common battery packs or independent battery packs for each UPS are allowed.
- 5) Refer to the following wiring diagram:

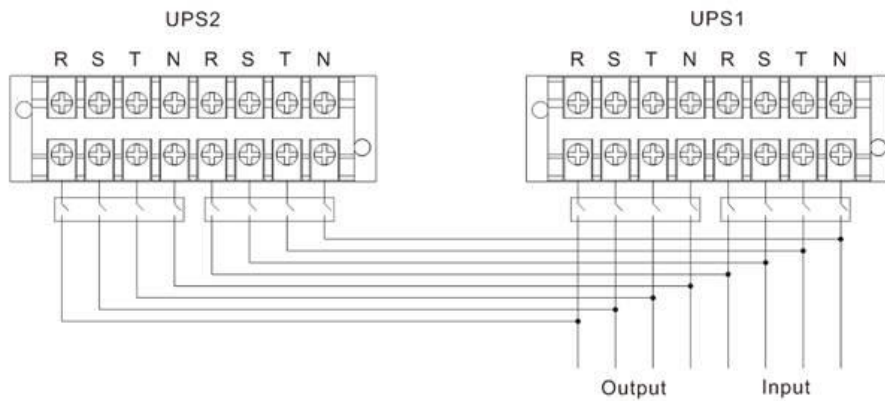

Wiring diagram of parallel system for HV10K(L)/15K(L)/20K(L) and LV 10K(L)

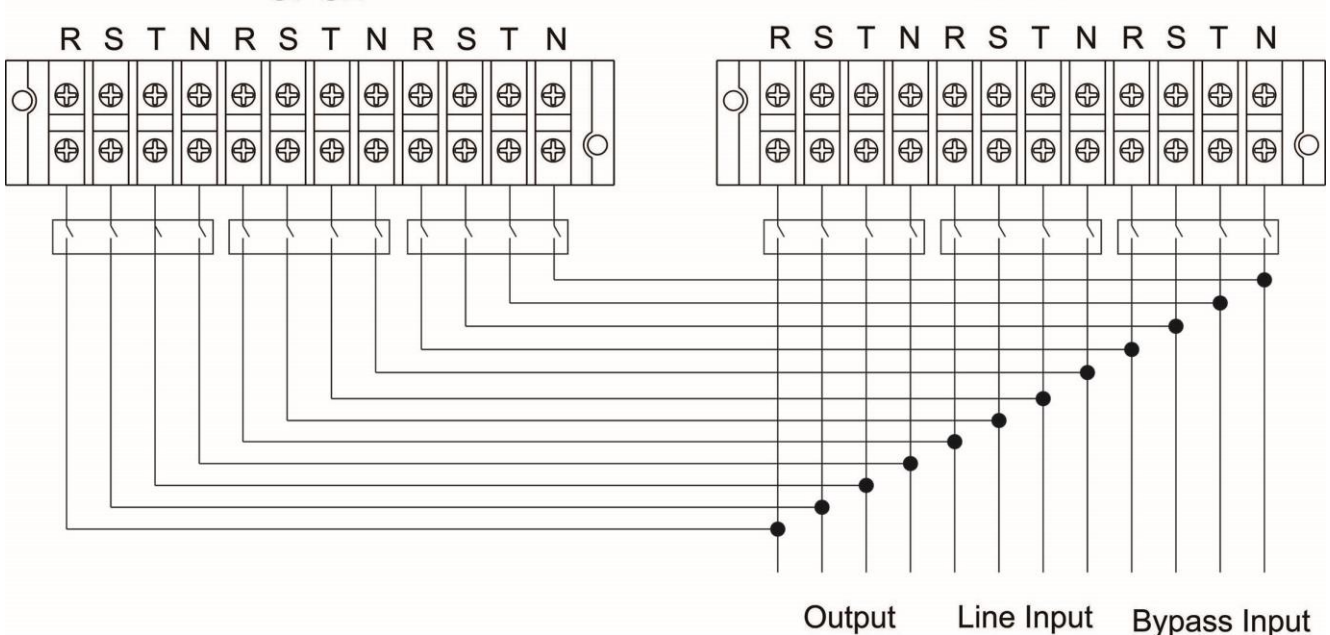

Wiring diagram of parallel system for HV10K(L)/15K(L)/20K(L) DUAL and LV 10K(L)DUAL

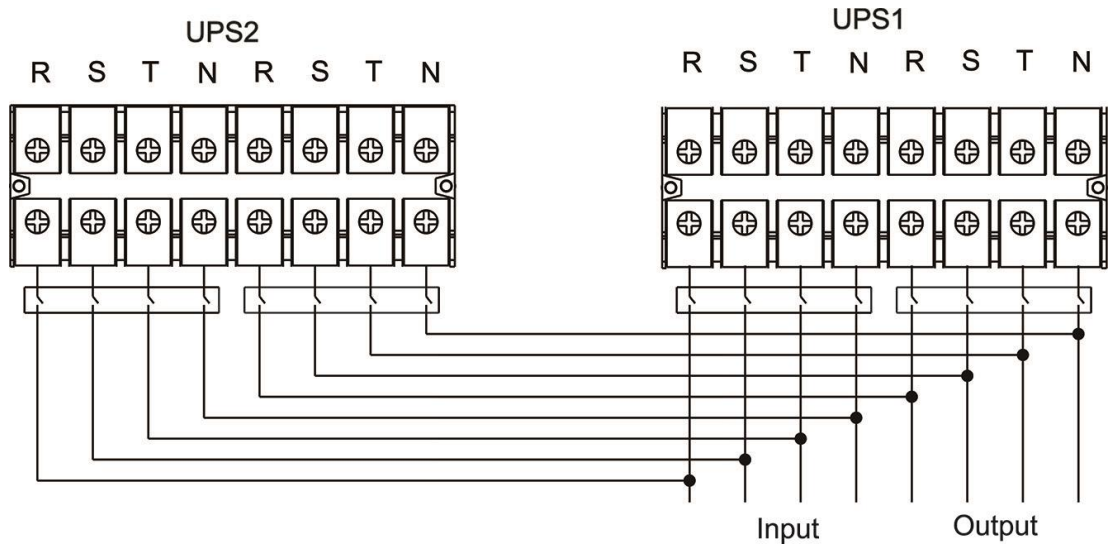

Wiring diagram of parallel system for HV 30K(L)/40K(L) and LV 15K(L)/20K(L)

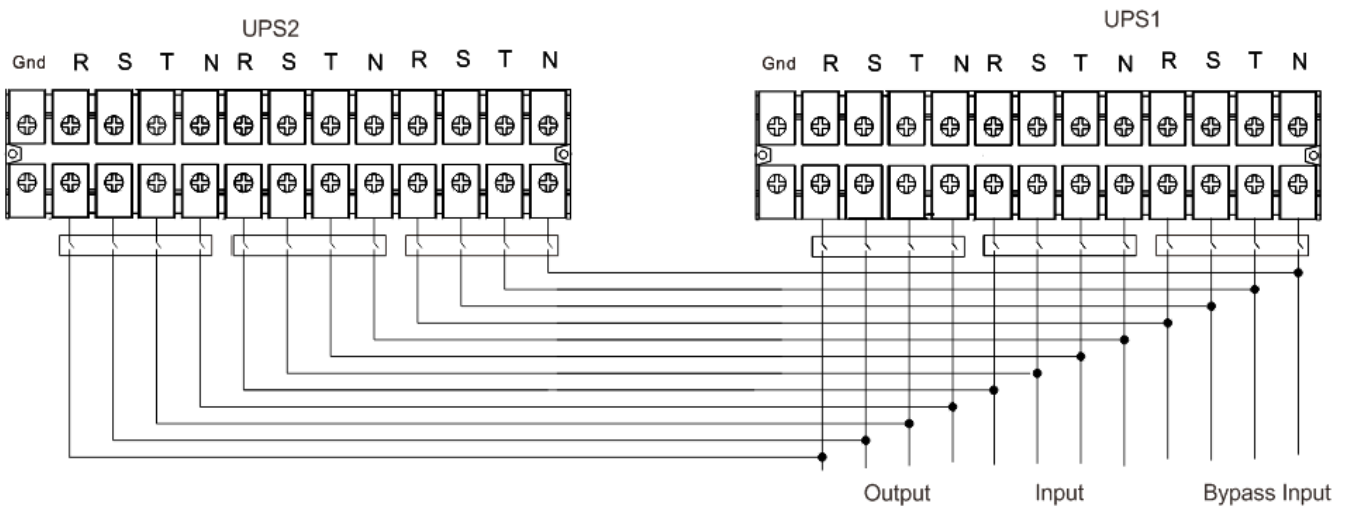

Wiring diagram of parallel system for HV 30K(L)/40K(L) DUAL and LV 15K(L)/20K(L) DUAL

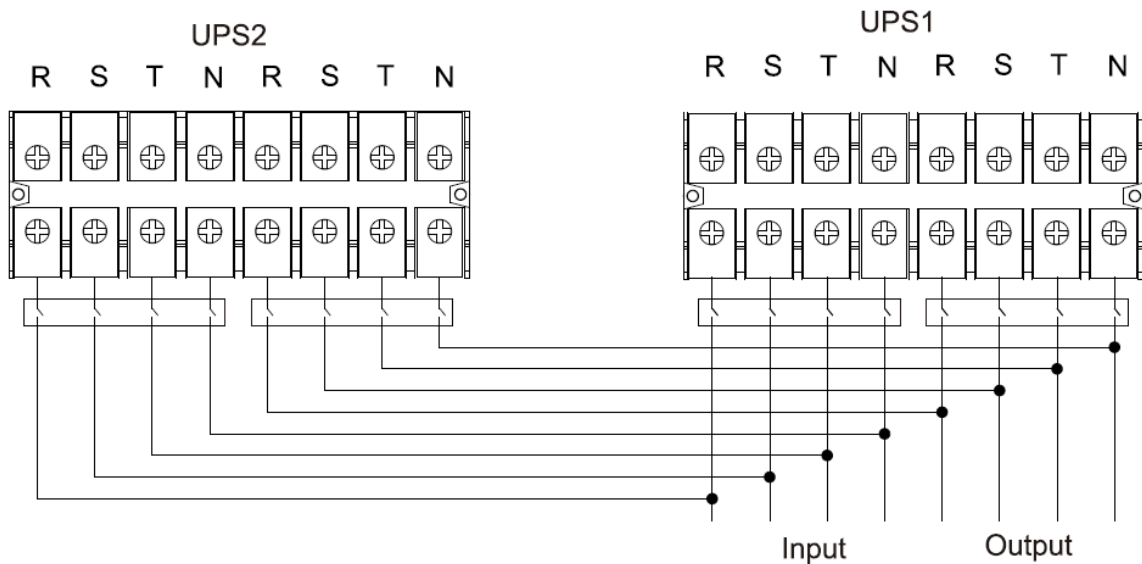

Wiring diagram of parallel system for HV 60KL/80KL and LV 30KL/40KL

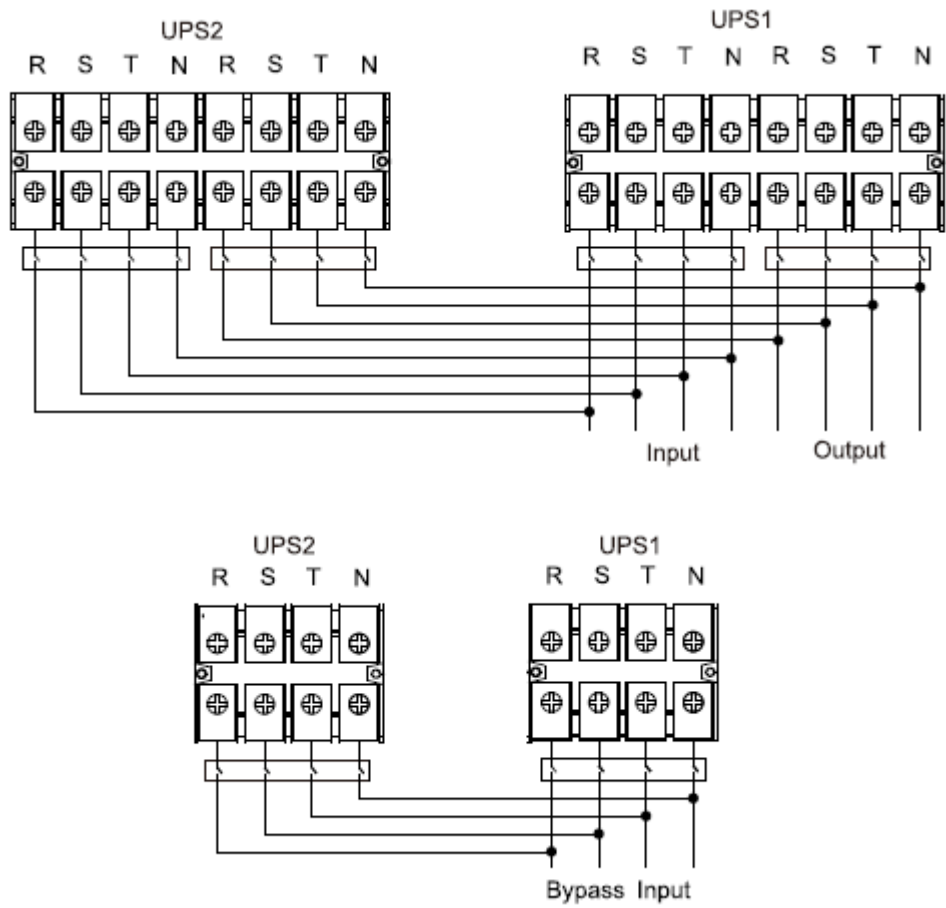

Wiring diagram of parallel system for HV 60KL DUAL /80KL DUAL and LV 30KL DUAL/40KL DUAL

2-5. Software Installation

For optimal computer system protection, install UPS monitoring software to configure UPS shutdown operation.

3. Operations

3-1. Button Operation

Button	Function
ON/Enter Button	<ul style="list-style-type: none"> ➤ Turn on the UPS: Press and hold the button more than 0.5s to turn on the UPS. ➤ Enter Key: Press this button to confirm the selection in the setting menu.
OFF/ESC Button	<ul style="list-style-type: none"> ➤ Turn off the UPS: Press and hold the button more than 0.5s to turn off the UPS. ➤ Esc key: Press this button to return to last item in the setting menu.
Test/Up Button	<ul style="list-style-type: none"> ➤ Battery test: Press and hold the button more than 0.5s to test the battery while in AC mode and CVCF* mode. ➤ UP key: Press this button to display next selection in the setting menu.
Mute/Down Button	<ul style="list-style-type: none"> ➤ Mute the alarm: Press and hold the button more than 0.5s to mute the buzzer. Please refer to section 3-4-9 for details. ➤ Down key: Press this button to display previous selection in the setting menu.
Test/Up + Mute/Down Button	<ul style="list-style-type: none"> ➤ Press and hold the two buttons simultaneous more than 1s to enter/escape the setting menu.

* CVCF means Constant Voltage and Constant Frequency.

3-2. LED Indicators and LCD Panel

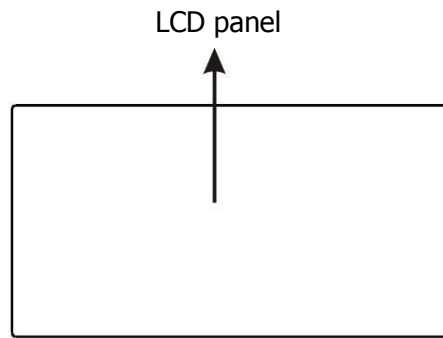

LED Indicators:

There are 4 LEDs on front panel to show the UPS working status:



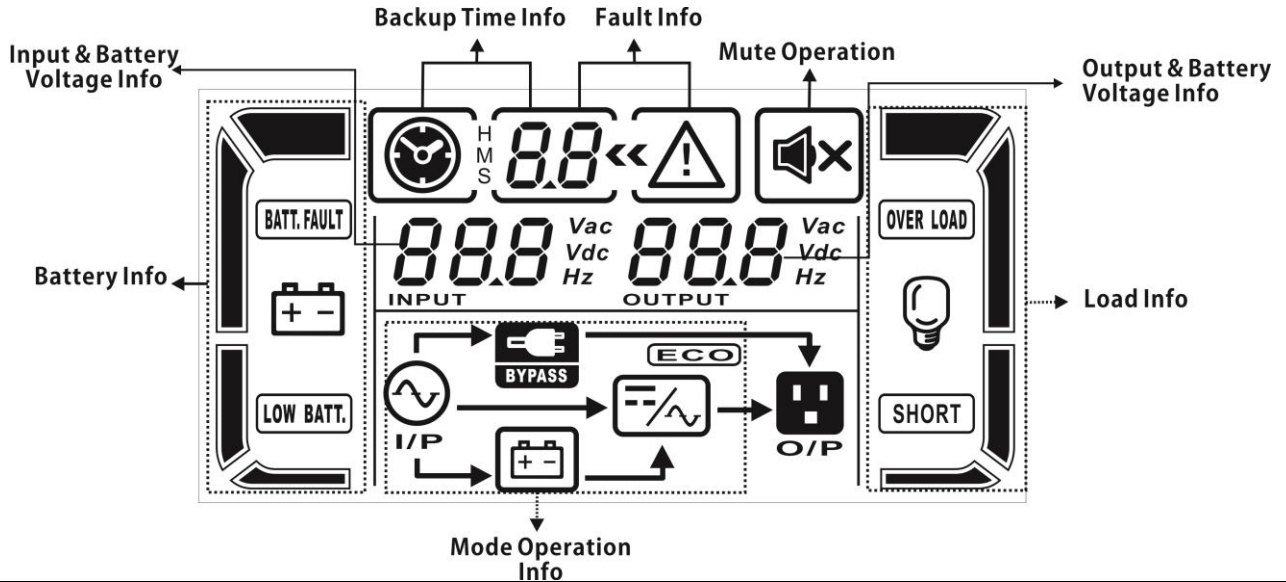

Mode \ LED	Bypass	Line	Battery	Fault
UPS On	●	●	●	●
No Output mode	○	○	○	○
Bypass mode	●	○	○	○
AC mode	○	●	○	○
Battery mode	○	○	●	○
CVCF mode	○	●	○	○
Battery Test	●	●	●	○
ECO mode	●	●	○	○
Fault	○	○	○	●

Note: ● means LED is lighting, and ○ means LED is faded.

LCD Panel:

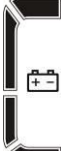

Display	Function
Backup time information	
	Indicates the battery discharge time in numbers H: hours, M: minutes, S: seconds
Fault information	
	Indicates that the warning and fault occurs.
	Indicates the fault codes, and the codes are listed in details in section 3-9.
Mute operation	
	Indicates that the UPS alarm is disabled.
Output & Battery voltage information	
	Indicates the output voltage, frequency or battery voltage. Vac: output voltage, Vdc: battery voltage, Hz: frequency
Load information	
	Indicates the load level by 0-25%, 26-50%, 51-75%, and 76-100%.
	Indicates overload.
	Indicates the load or the output is short.
Mode operation information	
	Indicates the UPS connects to the mains.
	Indicates the battery is working.
	Indicates the bypass circuit is working.
	Indicates the ECO mode is enabled.
	Indicates the Inverter circuit is working.
	Indicates the output is working.

Battery information	
	Indicates the battery capacity by 0-25%, 26-50%, 51-75%, and 76-100%.
	Indicates the battery is not connected.
	Indicates low battery level and low battery voltage.
Input & Battery voltage information	
	Indicates the input voltage or frequency or battery voltage. Vac: Input voltage, Vdc: battery voltage, Hz: input frequency

3-3. Audible Alarm

Description	Buzzer status	Muted
UPS status		
Bypass mode	Beeping once every 2 minutes	Yes
Battery mode	Beeping once every 4 seconds	
Fault mode	Beeping continuously	
Warning		
Overload	Beeping twice every second	No
Others	Beeping once every second	
Fault		
All	Beeping continuously	Yes

3-4. Single UPS Operation

1. Turn on the UPS with utility power (in AC mode)

- 1) After power mains is connected correctly, set the breaker of the battery pack to "ON" position (this step only necessary for long-run model). Then set the line input breaker to "ON" position. At the same time the fan will start running and the UPS will start initialization. In just a few seconds, the UPS will supply power to the loads via the Bypass mode.

NOTE: When UPS is in Bypass mode, the output voltage will be directed from mains after you switch on the input breaker. In Bypass mode, the load is not protected by the UPS. To protect your precious devices, you should turn on the UPS. Refer to next step.

- 2) Press and hold the "ON" button for 0.5s to turn on the UPS and the buzzer will sound once.
- 3) In just a few seconds, the UPS will enter into AC mode. If the mains is abnormal, the UPS will operate in Battery mode without interruption.

NOTE: When the UPS runs out battery, it will shut down automatically in Battery mode. When the mains is normalized, the UPS will auto restart in AC mode.

2. Turn on the UPS without utility power supply (in Battery mode)

- 1) Make sure that the two strings of batteries are connected correctly in order of "+,GND,-" terminals and the breaker of the battery pack is at "ON" position (only for long-run model).
- 2) Press the "ON" button to set up the power supply for the UPS. UPS will enter to power on mode. After initialization, UPS will enter to "No Output mode", then press and hold the "ON" button for 0.5s to turn on the UPS, and the buzzer will sound once.
- 3) A few seconds later, the UPS will be turned on and enter to Battery mode.

3. Connect devices to UPS

After the UPS is turned on, you can connect devices to the UPS.

- 1) Turn on the UPS first and then switch on the devices one by one. The LCD panel will display total load level.
- 2) If it is necessary to connect the inductive loads such as a printer, the in-rush current of the load should be calculated carefully to see if it meets the overload capability of the UPS. Any load more than 150% over designed capacity the runtime will be less than 60ms
- 3) If the UPS is overload, the buzzer will beep twice every second.
- 4) When the UPS is overload, please remove some loads immediately. It is recommended to have the total loads connected to the UPS less than 80% of its nominal power capacity to prevent overload for system safety.
- 5) If the overload time is over acceptable time listed in spec in AC mode, the UPS will automatically transfer to Bypass mode. After the overloading was resolved, it will return back to AC mode. If the overload time is over acceptable time listed in spec in Battery mode, the UPS will enter fault status. At this time, if bypass is enabled, the UPS will power to the load via bypass. If bypass function is disabled or the input power is not within bypass acceptable range, it will cut off output entirely.

4. Charge the batteries

- 1) After the UPS is connected to the mains and turned on in AC mode, the charger will charge the batteries automatically except in battery mode, during battery self-test, overload or when battery voltage is high.
- 2) It's recommended to charge batteries for at least 10 hours before operation. Otherwise, the backup time may be shorter than expected.

5. Battery mode operation

- 1) When the UPS is in Battery mode, the buzzer will sound according to different battery capacity. If the battery capacity is more than 25%, the buzzer will beep once every 4 seconds. If the battery voltage drops to the alarm level, the buzzer will beep once every sec to remind users that the battery is at low level and the UPS will shut down imminently. Users could switch off some non-critical loads to disable the shutdown alarm and prolong the backup time. If there is no more load to be switched off, you have to prepare shutdown procedure to preserve working data or devices. Otherwise, there is a risk of data loss or load failure.
- 2) In Battery mode, users can press the Mute button to disable the buzzer.
- 3) The backup time of the long-run model depends on the external battery capacity.
- 4) The backup time may vary from different operating temperature and load type.
- 5) When setting backup time for 16.5 hours (default value from LCD menu), after discharging 16.5 hours, UPS will shut down automatically to protect the battery. This battery discharge protection can be enabled or disabled through LCD menu. (Refer to 3-7 for details)

6. Test the batteries

- 1) If you need to check the battery status when the UPS is running in AC mode/CVCF mode, you could press the "Test" button for battery self-test.
- 2) Users also can set battery self-test through monitoring software.

7. Turn off the UPS with utility power supply in AC mode

- 1) Turn off the inverter of the UPS by pressing "OFF" button for at least 0.5s, and then the buzzer will sound once. The UPS will enter into Bypass mode.

NOTE 1: If the UPS has been set to bypass output, it will bypass voltage from the mains to output terminal even though you have turned off the UPS (inverter).

NOTE 2: After turning off the UPS, please be aware that the UPS is working in Bypass mode, there will be risk of power loss for connected devices.

- 2) In Bypass mode, output voltage of the UPS is still present. In order to cut off the output, switch off the line input breaker. The LCD display will turn off and UPS is now completely off.

8. Turn off the UPS without utility power supply in Battery mode

- 1) Turn off the UPS by pressing "OFF" button for at least 0.5s, and then the buzzer will sound once.
- 2) Then UPS will cut off power to output terminals and there will no display shown on the LCD panel.

9. Mute the buzzer

- 1) To mute the buzzer, please press the "Mute" button for at least 0.5s. If you press it again after the buzzer is muted, the buzzing will resume.
- 2) Some warning alarms can't be muted unless the error is fixed. Please refer to section 3-3 for details.

10. Operation in warning status

- 1) When Fault LED illuminates and the buzzer beeps once every second, it indicates that there are problems for UPS operation. Users can read the warning message(s) from LCD menu. Please refer to the Chapter 4 for details.
- 2) Some warning alarms can't be muted unless the error is fixed. Please refer to section 3-3 for details.

11. Operation in Fault mode

- 1) When Fault LED illuminates and the buzzer beeps continuously, it means that there is a fatal error with the UPS. Users can get the fault code from LCD menu. Please refer to the Chapter 4 for details.
- 2) Please check the loads, wiring, ventilation, mains, battery and so on after the fault occurs. Don't try to turn on the UPS again before solving the issues. If the problems persist, contact the distributor or service personnel immediately.
- 3) In case of an emergency, shut off connections from mains, external battery, and output immediately to avoid possible damage to the UPS or equipment.

12. Operation in maintenance mode

This operation should only be performed by maintenance personnel or qualified technicians.

When the UPS needs to repair or service and the load could not be shut off, the UPS needs to be put into maintenance mode.

- 1) First, switch off the UPS.
- 2) Then, remove the cover of maintenance bypass switch on the panel.
- 3) Turn the maintenance switch to "BPS" position. Then, turn off the UPS input breaker and output breaker.

13. Operation in changing battery quantity

- 1) This operation should only be performed by maintenance personnel or qualified technicians.
- 2) Turn off the UPS. If the load cannot be shut off, you should remove the cover of maintenance bypass switch on the panel and turn the maintenance switch to "BPS" position.
- 3) Switch off the line input breaker and external bypass input breaker (only for dual-input model). Then, UPS will enter into "No Output mode".
- 4) Connect communication cable to the UPS and a computer. Be sure to install communication tool first. For this software tool, please check your local dealer for the details. Use the software to set up battery quantity accordingly. Or use LCD setting interface to set the battery quantity directly, please contact with the local after-sales service.
- 5) After settings are updated successfully, shut down the UPS with battery connected to save the change parameter. Then, modify the connected battery pack numbers accordingly.
- 6) Switch on the utility power breaker and external bypass input breaker (only for dual-input model).

Then, the UPS will enter into bypass mode. If the UPS is in maintenance bypass mode, turn the maintenance switch back to "UPS" position and then turn on the UPS.

NOTE: If you see warning code "01", the UPS is not able to set up the battery quantity. Only in No output mode can battery quantity be modified.

14. Operation in setting charging current

- 1) This operation should only be performed by maintenance personnel or qualified technicians.
- 2) Connect communication cable to the UPS and a computer. Be sure to install communication tool first. For this software tool, please check your local dealer for the details. Use the software to set up charging current accordingly. Or Use LCD setting interface to set charge current directly, please refer to chapter 3-7 interface 21.
- 3) After settings are updated successfully, the updated charging current will take effect immediately. The UPS would need to be restarted to saving the setting.

15. Operation in setting charger quantity

- 1) This operation should only be performed by maintenance personnel or qualified technicians.
- 2) Turn off the UPS. If the load can not be cut off, you should remove the cover of maintenance bypass switch on the panel and turn the maintenance switch to "BPS" position.
- 3) Switch off the line input breaker and UPS will enter into "No Output mode".
- 4) Connect communication cable to the UPS and a computer. Be sure to install communication tool first. For this software tool, please check your local dealer for the details. Use the software to set up charger quantity accordingly.
- 5) After settings have been successfully updated, restart the UPS with battery connected to save the change. Then, modify the connected charger numbers accordingly.
- 6) Switch on the line input breaker and external bypass input breaker (only for dual-input model). Then, the UPS will enter into Bypass mode. If the UPS is in maintenance bypass mode, turn the maintenance switch to "UPS" position and then turn on the UPS.

NOTE: The charger quantity setting must coincide with actual number installed in the UPS. If the setting quantity is more than actual installed quantity, the charging current will not meet the specification.

3-5. Parallel Operation

1. Parallel system initial startup

Please make sure that all of the running UPSs are parallel models and have the same configuration.

- 1) Turn on each UPS in AC mode respectively (Refer to section 3-4(1)). Then, measure the inverter output voltage of each phase for each UPS with a multi-meter. Calibrate the inverter output voltage by configuring inverter voltage adjustment (Refer to Program 15, 16 and 17 in section 3-7) in LCD menu until the inverter output voltage difference of each UPS is within 1V or less.
- 2) Calibrate the output voltage measurement by configuring output voltage calibration(Refer to Program 18,19, and 20, section 3-7) in LCD setting to make sure the difference between real output voltage and detected value of UPS is less than 1V.
- 3) Turn off each UPS (Refer to section 3-4(7.)). Then, follow the wiring procedure in section 2-4.
- 4) Remove the cover of parallel share current cable port on the UPS, connect each UPS one by one with the parallel cable and share current cable, and then replace the cover.
- 5) **Turn on the parallel system in AC mode:**
 - a) Turn on the line input breaker of each UPS. If using dual-input unit, please also turn on bypass input breaker. After all UPSs enter into bypass mode, measure the output voltage between two UPSs for the same phase to make sure the phase sequence is correct. If these two voltage differences are near to zero, that means all connections are met. Otherwise, please check if the wirings are connected correctly.
 - b) Turn on the output breaker of each UPS.
 - c) Turn on each UPS in turns. After a while, the UPSs should enter into AC mode synchronously and then, the parallel system is now complete.
- 6) **Turn on the parallel system in Battery mode:**
 - a) Turn on the battery breaker (only available in long-run model) and external output breaker of each UPS.
 - b) Turn on any UPS. A few seconds later, the UPS will enter into battery mode.
 - c) Turn on the next UPS in sequence until all the UPSs enter into Battery mode and add to the parallel system. Now the parallel system is now complete.

If you would like to have more information regarding the parallel operation, please contact your supplier or service center for detail parallel operation instruction.

2. Add new units into the parallel system

- 1) You can not add new unit into the parallel system when whole system is running. You must cut off the load and shutdown the system.
- 2) Make sure all of the UPS are the parallel models, and follow the wiring reference in section 2-4.
- 3) Install the new parallel system as per section 3-5.

3. Remove units from the parallel system

There are two methods to remove units from the parallel system:

First method:

- 1) Press the "OFF" key twice and each press should be last for more than 0.5s. Then, the UPS will enter into Bypass mode or No Output mode without output.
- 2) Turn off the external output breaker of this unit, and then turn off the input breaker of this unit.
- 3) After this UPS shuts down, turn off the battery breaker (for long-run model) and remove the parallel and share current cables. And then remove the unit from the parallel system.

Second method:

- 1) If the bypass is abnormal, you can not remove the UPS without interruption. You must cut off the load and shut down the system.
- 2) Make sure the bypass setting is enabled in each UPS and then turn off the system. All UPSs will

transfer to Bypass mode. Remove all the maintenance bypass covers and set the maintenance switches from "UPS" to "BPS" position. Turn off all the input breakers and battery breakers in parallel system.

- 3) Turn off the output breaker and remove the parallel cable and share current cable of the UPS which you want to remove. Now, you can remove the UPS from parallel system.
- 4) Turn on the input breaker of the remaining UPS and the system will transfer to Bypass mode. Set the maintenance switches from "BPS" to "UPS" position and put the maintenance bypass covers back on.
- 5) Turn on the remaining UPS according to the previous section.



Warning: (Only for the parallel system)

- Before turning on the parallel system to activate inverter, make sure that all unit's maintenance switch at the same position.
- When parallel system is turned on, please do not operate the maintenance switch of any unit.
- The parallel system DOES NOT support ECO mode. Therefore, please DO NOT "enable" ECO mode in any unit.

3-6. Abbreviation Meaning in LCD Display

Abbreviation	Display content	Meaning
ENA	ENA	Enable
DIS	DIS	Disable
ATO	ATO	Auto
BAT	BAT	Battery
NCF	NCF	Normal mode (not CVCF mode)
CF	CF	CVCF mode
SUB	SUB	Subtract
ADD	ADD	Add
ON	ON	On
OFF	OFF	Off
FBD	FBD	Not allowed
OPN	OPN	Allow
RES	RES	Reserved
N.L	NL	Neutral line loss
CHE	CHE	Check
OP.V	OPV	Output voltage
PAR	PAR	Parallel, 001 means the first UPS
AN	AN	The first phase
BN	BN	The second phase
CN	CN	The third phase
AB	Ab	The first line
BC	bC	The second line
CA	CA	The third line

HS.H	HS.H	Hot Standby
------	------	-------------

3-7. LCD Setting

There are three parameters to set up the UPS. Refer to following diagram.

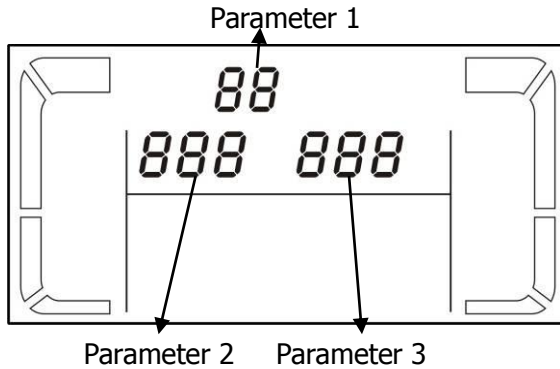

Parameter 1: It's for program alternatives. Refer to below tables for the programs to set up.

Parameter 2 and parameter 3 are the setting options or values for each program.

Note: Please select "Up" or "Down" button to change the programs or parameters.

Programs available list for parameter 1:

Code	Description	Bypass / No Output mode	AC mode	ECO mode	CVCF mode	Battery mode	Battery Test
01	Output voltage	Y*					
02	Output frequency	Y					
03	Reserved	Reserved for future options					
04	Reserved	Reserved for future options					
05	ECO mode enable/disable	Y					
06	Reserved	Reserved for future options					
07	Reserved	Reserved for future options					
08	Bypass mode setting	Y	Y				
09	Maximum battery discharge time setting	Y	Y	Y	Y	Y	Y
10	Reserved	Reserved for future options					
11	Hot standby function Setting	Y					
12	Neutral loss detection	Y	Y	Y	Y	Y	Y
13	Battery voltage calibration	Y	Y	Y	Y	Y	Y
14	Charger voltage adjustment	Y	Y	Y	Y	Y	Y
15	Inverter A voltage adjustment		Y		Y	Y	
16	Inverter B voltage adjustment		Y		Y	Y	
17	Inverter C voltage adjustment		Y		Y	Y	
18	Output A voltage calibration		Y		Y	Y	
19	Output B voltage calibration		Y		Y	Y	
20	Output C voltage calibration		Y		Y	Y	
21	Charging current setting	Y	Y	Y	Y	Y	Y
22	Battery number setting	Y					



*Y means that this program can be set in this mode.

Note: All parameter settings will be saved only when UPS shuts down normally with internal or external battery connection. (Normal UPS shutdown means turning off input breaker in bypass/no output mode).

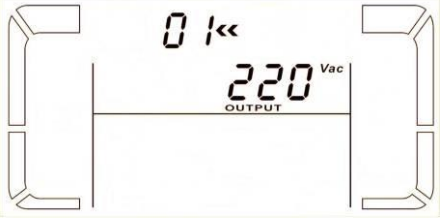
● **01: Output voltage**

Interface	Setting
	<p>Parameter 3: Output voltage For 208/220/230/240 VAC models, you may choose the following output voltage: 208: presents output voltage is 208Vac 220: presents output voltage is 220Vac 230: presents output voltage is 230Vac 240: presents output voltage is 240Vac For 120/127 VAC models, you may choose the following output voltage: 120: presents output voltage is 120Vac 127: presents output voltage is 127Vac</p>

● **02: Output frequency**

Interface	Setting
<p>60 Hz, CVCF mode</p>  <p>50 Hz, Normal mode</p>  <p>ATO</p> 	<p>Parameter 2: Output Frequency Setting the output frequency. You may choose following three options in parameter 2: 50.0Hz: The output frequency is setting for 50.0Hz. 60.0Hz: The output frequency is setting for 60.0Hz. ATO: If selected, output frequency will be decided according to the latest normal utility frequency. If it is from 46Hz to 54Hz, the output frequency will be 50.0Hz. If it is from 56Hz to 64Hz, the output frequency will be 60.0Hz. ATO is default setting.</p> <p>Parameter 3: Frequency mode Setting output frequency at CVCF mode or not CVCF mode. You may choose following two options in parameter 3: CF: Setting UPS to CVCF mode. If selected, the output frequency will be fixed at 50Hz or 60Hz according to setting in parameter 2. The input frequency could be from 46Hz to 64Hz. NCF: Setting UPS to normal mode (not CVCF mode). If selected, the output frequency will synchronize with the input frequency within 46~54 Hz at 50Hz or within 56~64 Hz at 60Hz according to setting in parameter 2. If 50 Hz selected in parameter 2, UPS will transfer to battery mode when input frequency is not within 46~54 Hz. If 60Hz selected in parameter 2, UPS will transfer to battery mode when input frequency is not within 56~64 Hz. *If Parameter 2 is ATO, the Parameter 3 will show the current frequency.</p>

● **03: Reserved**

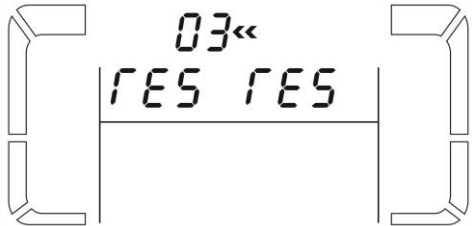
Interface	Setting
	<p>Reserve for future options.</p>

● **04: Reserved**

Interface	Setting
	Reserve for future options.

● **05: ECO mode enable/disable**

Interface	Setting
	<p>Parameter 3: Enable or disable ECO function. You may choose following two options: DIS: disable ECO function ENA: enable ECO function If ECO function is disabled, voltage range and frequency range for ECO mode still can be set, but it is meaningless unless the ECO function is enabled. *If the system is running in parallel, be sure to set "DIS" only.</p>

● **06: Reserved**

Interface	Setting
	Reserve for future options.

● **07: Frequency range for ECO mode**

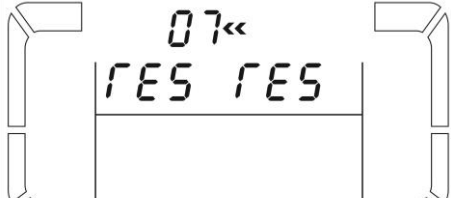
Interface	Setting
	Reserve for future options.

● **08: Bypass mode setting**

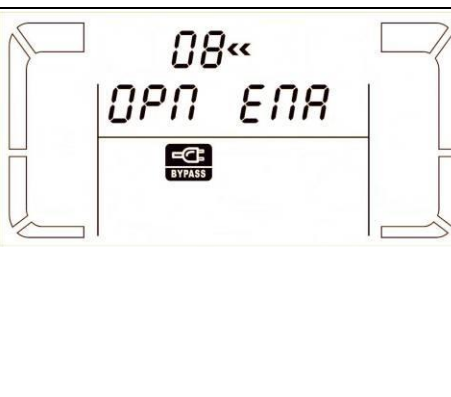
Interface	Setting
	<p>Parameter 2: OPN: Bypass allowed. When selected, UPS will run at Bypass mode depending on bypass enabled/disabled setting. FBD: Bypass not allowed. When selected, it's not allowed for running in Bypass mode under any situations. Parameter 3: ENA: Bypass enabled. When selected, Bypass mode is activated. DIS: Bypass disabled. When selected, automatic bypass is acceptable, but manual bypass is not allowed. Manual bypass means users manually operate UPS for Bypass mode. For example, pressing OFF button in AC mode to turn into Bypass mode.</p>

● **09: Maximum battery discharge time setting**

Interface	Setting
	<p>Parameter 3: 000~999: Set the maximum discharge time from 0 min to 999 min. UPS will shut down to protect battery if the discharge time arrives before the battery is under voltage. The default value is 990 min. DIS: Disable battery discharge protection and backup time will depend on battery capacity.</p>

● **10: Reserved**

Interface	Setting
	<p>Reserve for future options.</p>

● **11: Hot standby function Setting**

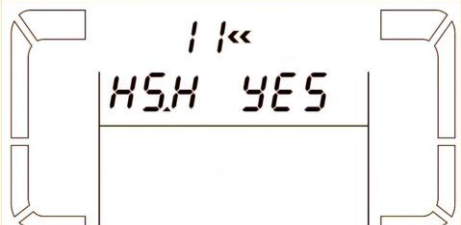
Interface	Setting
	<p>Parameter 2: HS.H: Indicates Hot standby function. Parameter 3: Enable or disable hot standby function. YES: Hot standby function is enabled. It means that the current UPS is set to host of the hot standby function, and it will restart After AC recovery even without battery connected. NO: Hot standby function is disabled. The UPS is running at Normal mode and can't restart without battery.</p>

● **12: Neutral loss detection**

Interface	Setting
	<p>Parameter 2: N.L: Indicates neutral loss detection function. Parameter 3: DIS: Disable the neutral loss detection function. The UPS will not detect the neutral loss or not. ATO: The UPS will automatically detect the neutral is lost or not. If neutral loss is detected, an alarm will be generated. If the UPS is turned on, it will transfer to battery mode. When neutral is restored and detected, the alarm will be muted automatically and the UPS will go back to normal mode automatically. CHE: The UPS will automatically detect the neutral loss. If neutral loss is detected, an alarm will be generated. If the UPS is turned on, it will transfer to battery mode. When neutral is restored, the alarm will NOT be muted automatically and the UPS will NOT go back to normal mode automatically. Here, you must mute the alarm and make the UPS go back to normal mode manually. The operation is: Firstly, enter this menu and press the "Enter" key to make the "CHE" flash. Secondly, press the "Enter" key again to activate the neutral detection (check). If neutral is detected, the alarm will be muted and the UPS will go back to normal mode. If neutral is not detected, the UPS will continue alarming and stay on the latest status until the neutral is detected well at next manual checking operation.</p>

CHE is default setting.

● **13: Battery voltage calibration**

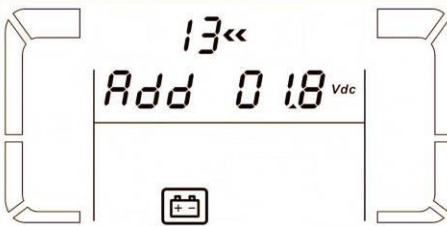
Interface	Setting
	<p>Parameter 2: Select "Add" or "Sub" function to adjust battery voltage to real figure.</p> <p>Parameter 3: the voltage range is from 0V to 9.9V and the default value is 0V.</p>

● **14: Charger voltage adjustment**

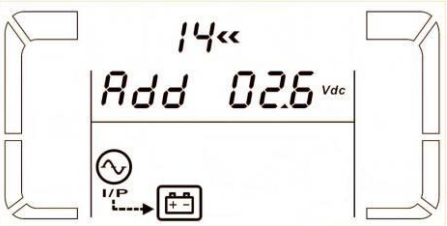
Interface	Setting
	<p>Parameter 2: you may choose Add or Sub to adjust charger voltage</p> <p>Parameter 3: the voltage range is from 0V to 9.9V and the default value is 0V.</p> <p>NOTE:</p> <ul style="list-style-type: none"> *Before making voltage adjustment, be sure to disconnect all batteries first to get the accurate charger voltage. * Any modification should be suitable to battery specifications.

● **15: Inverter A voltage adjustment**

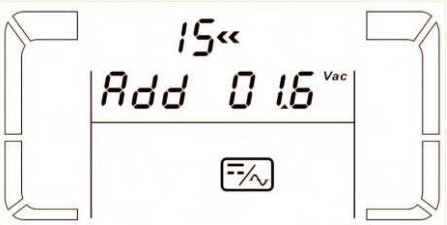
Interface	Setting
	<p>Parameter 2: you may choose Add or Sub to adjust inverter A voltage.</p> <p>Parameter 3: the voltage range is from 0V to 9.9V and the default value is 0V.</p> <ul style="list-style-type: none"> * Add or Sub is according to the output voltage what you set.

● **16: Inverter B voltage adjustment**

Interface	Setting
	<p>Parameter 2: you may choose Add or Sub to adjust inverter B voltage*.</p> <p>Parameter 3: the voltage range is from 0V to 9.9V and the default value is 0V.</p> <ul style="list-style-type: none"> *It will display number 1 under <i>Add</i> or <i>Sub</i> to represent inverter B voltage.

● **17: Inverter C voltage adjustment**

Interface	Setting
	<p>Parameter 2: you may choose Add or Sub to adjust inverter C voltage*.</p> <p>Parameter 3: the voltage range is from 0V to 9.9V, the default value is 0V.</p> <ul style="list-style-type: none"> *It will display number 2 under <i>Add</i> or <i>Sub</i> to represent inverter C voltage.

● **18: Output A voltage calibration**

Interface	Setting
	<p>Parameter 2: it always shows OP.V as output voltage. Parameter 3: it shows the internal measurement value of the output A voltage, and you can calibrate it by pressing Up or Down according to the measurement from an external voltage meter. The calibration result will be effective by pressing Enter. The calibration range is limited within +/-9V. This function is normally used for parallel operation.</p>

● **19: Output B voltage calibration**

Interface	Setting
	<p>Parameter 2: it always shows OP.V as output voltage*. Parameter 3: it shows the internal measurement value of the output B voltage, and you can calibrate it by pressing Up or Down according to the measurement from an external voltage meter. The calibration result will be effective by pressing Enter. The calibration range is limited within +/-9V. This function is normally used for parallel operation.</p> <p>*It will display number 1 under OPU to represent the output B voltage.</p>

● **20: Output C voltage calibration**

Interface	Setting
	<p>Parameter 2: it always shows OP.V as output voltage. Parameter 3: it shows the internal measurement value of the output C voltage, and you can calibrate it by pressing Up or Down according to the measurement from an external voltage meter. The calibration result will be effective by pressing Enter. The calibration range is limited within +/-9V. This function is normally used for parallel operation.</p> <p>*It will display number 2 under OPU to represent the output C voltage.</p>

● **21: Charging current setting**

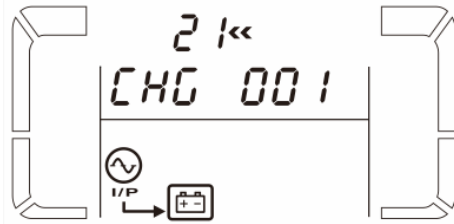
Interface	Setting
	<p>Parameter 2: it always shows CHG as Charging current. Parameter 3: The setting range is from 1A to 12A and the default value is 1A.</p>

● **22: Battery numbers setting**

Interface	Setting
	<p>The Battery numbers setting menu will be displayed only after entering the password. Please enter password "616" by pressing "Up" and "OFF" button to access setting menu. Press "Up" and "OFF" buttons at the same time to exit the menu.</p>

	<p>It always shows BAT to indicate battery numbers in parameter 2. It will show the internal measurement value of battery numbers in parameter 3 and you can change it by pressing Up or Down button. The setting range of battery numbers is from 16PCS to 20PCS. The setting result will be effective by pressing "Enter" button.</p> <p>After pressing "Enter" button, it will show "CHG" in parameter 3 to enter charger on/off setting menu.</p> <p>It shows "ON" or "OF" as charger status in parameter 1. This setting can be changed by pressing "Up" or "Down" button. The setting result will be effective by pressing "Enter" button.</p>

3-8. Operating Mode/Status Description

Following table shows LCD display for operating modes and status.

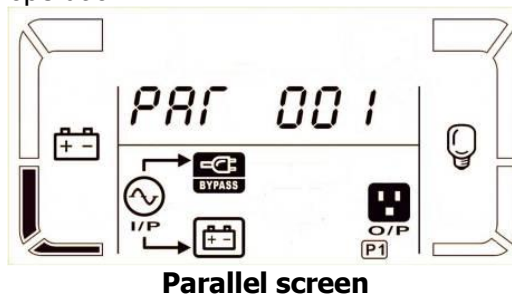

(1) If the UPS is in normal operation, it will show seven screens one by one, which represents 3 phase input voltages (An, bn, Cn), 3 line input voltages (Ab, bC, CA) and frequency on one screen.

(2) If a parallel UPS system is successfully set up, it will show one more screen with "**PAR**" in parameter 2 and assigned number in parameter 3 as below parallel screen diagram. The master UPS will be default assigned as "**001**" and slave UPSs will be assigned as either "002" or "003". The assignment may be changed dynamically in the UPS operation.

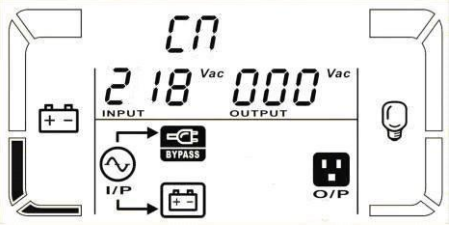
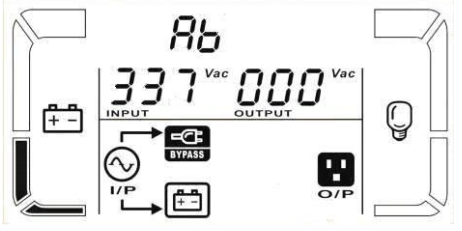
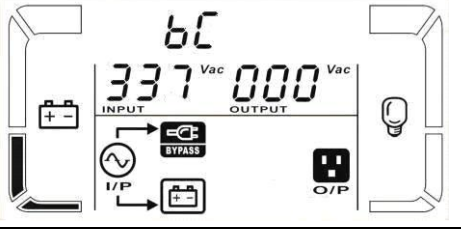
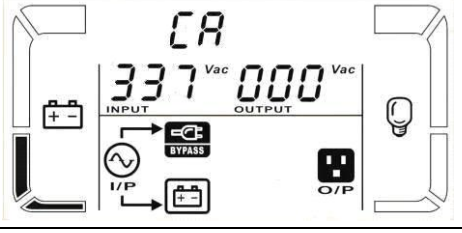
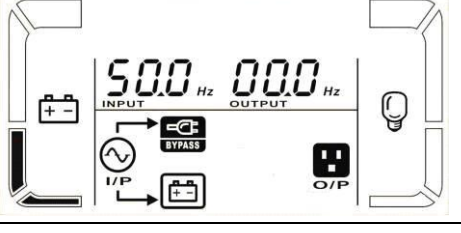
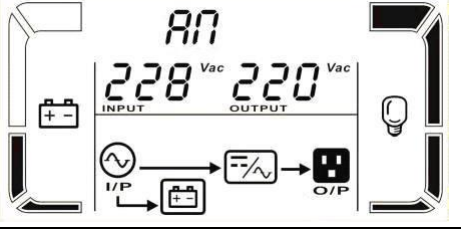
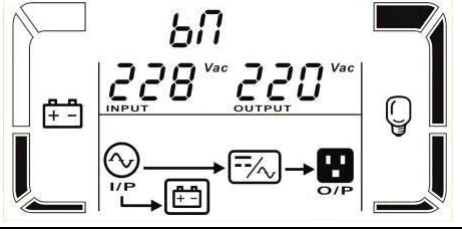
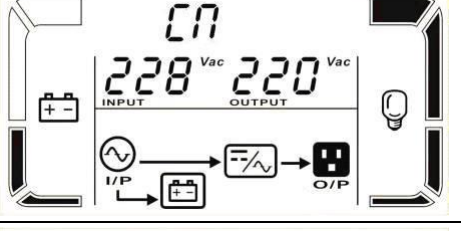
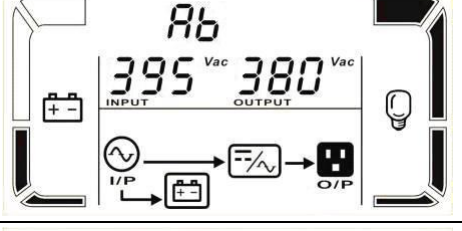
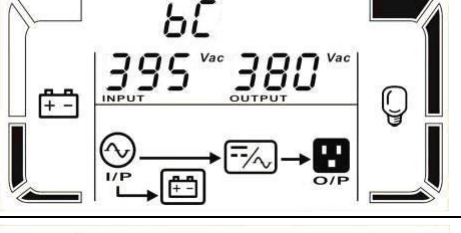
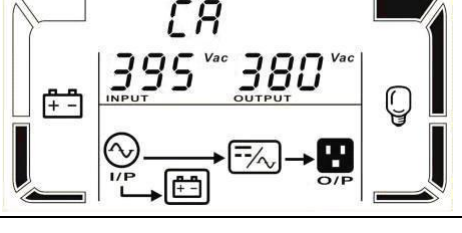
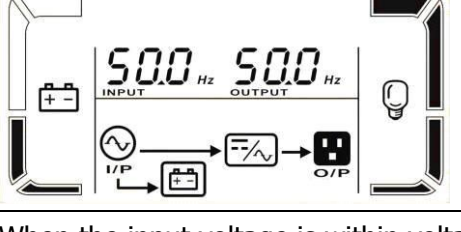

Operating mode/status		
UPS Power On	Description	When UPS is powered on, it will enter into this mode for a few seconds as initializing the CPU and system.
	LCD display	
No-output mode	description	When bypass voltage/frequency is out of acceptable range or bypass is disabled (or forbidden), UPS will enter into no-output mode if powering on or turning off the UPS. It means the UPS has no output. Alarm beeps every two minutes.
	LCD display	

		 
		 
		
AC mode	Description	When the input voltage is within acceptable range, UPS will provide pure and stable AC power to output. The UPS will also charge the battery at AC mode.
	LCD display	 
		 
		 
		
ECO mode	Description	When the input voltage is within voltage regulation range and ECO mode is enabled, UPS will bypass voltage to output for energy saving.

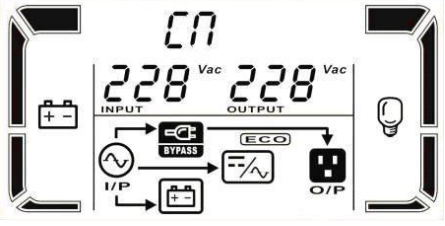
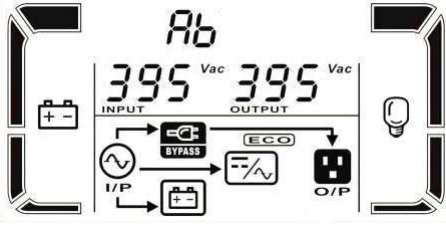
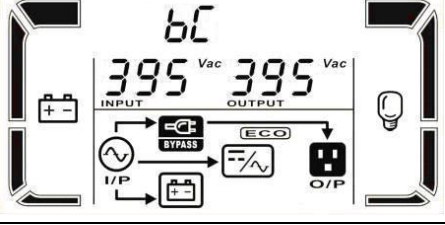
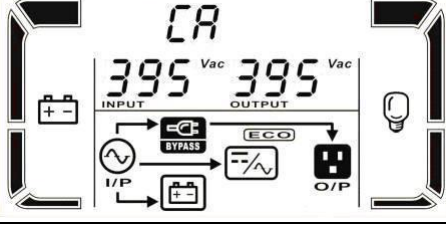
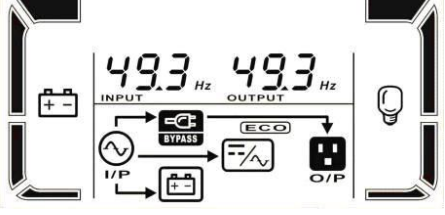
	LCD display		
			
			
			







CVCF mode

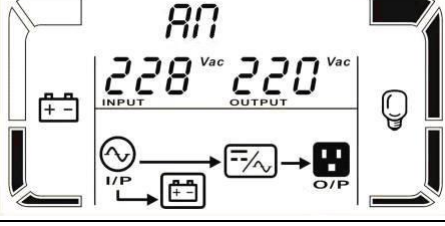
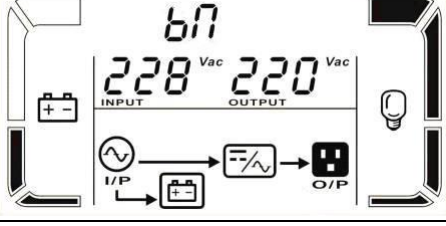
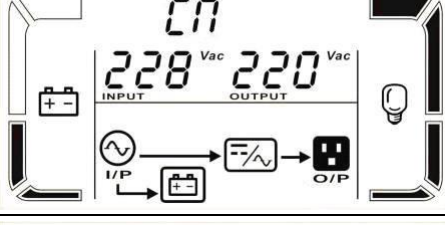
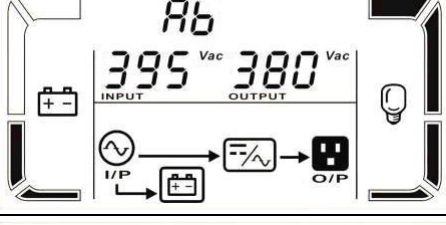
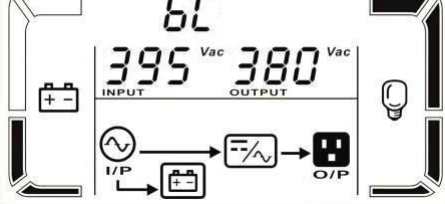
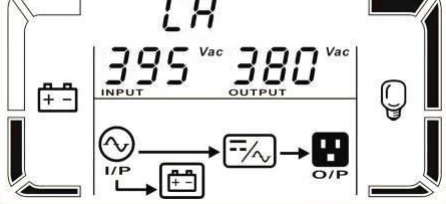

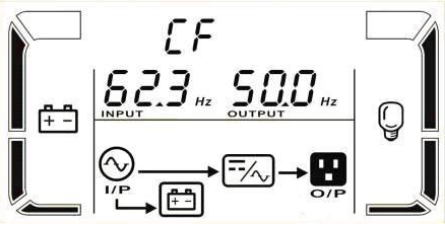
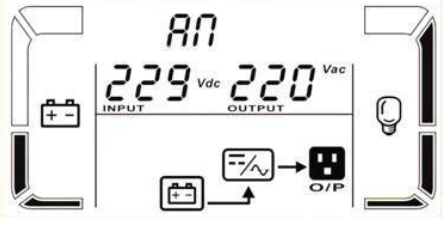
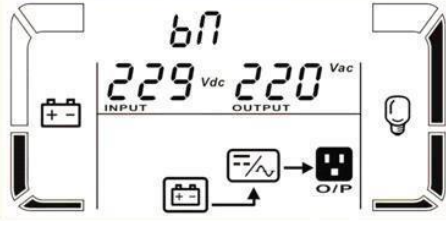
Description

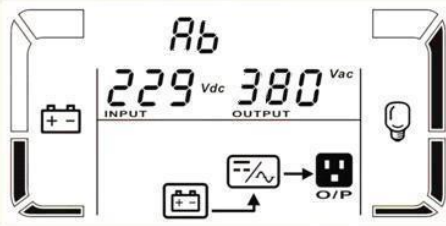
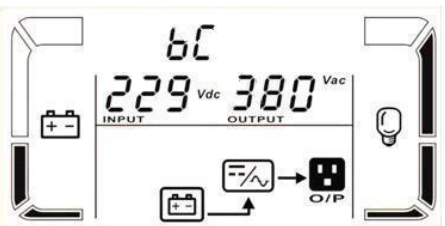

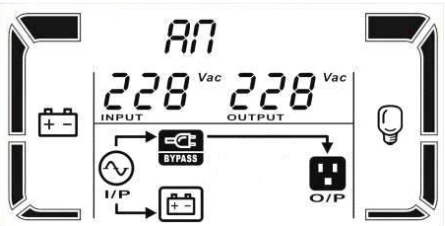
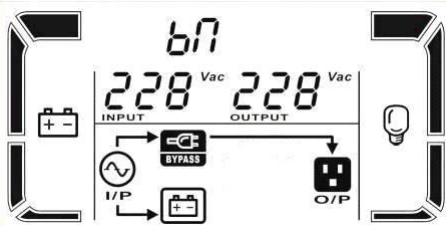
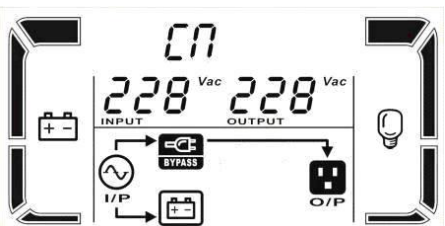

When the output frequency is set to "CF", the inverter will output constant frequency (50 Hz or 60 Hz). At this mode, the UPS will have no bypass output but still charge battery.

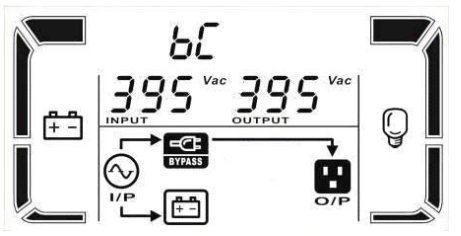
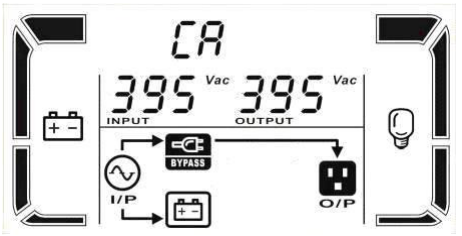
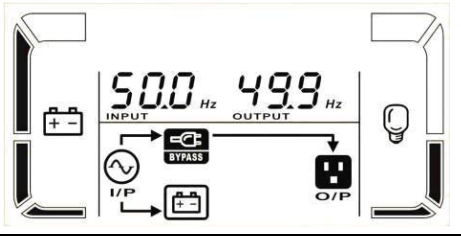
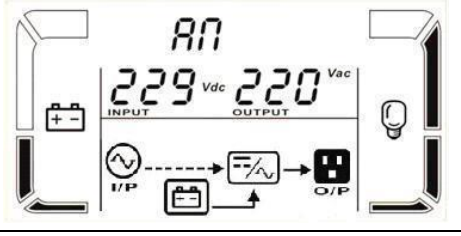
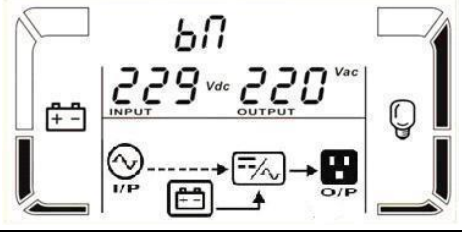
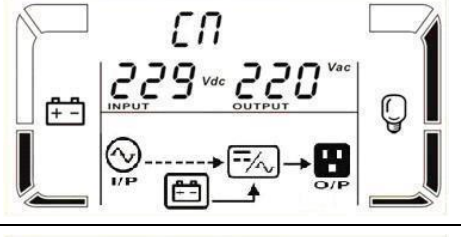
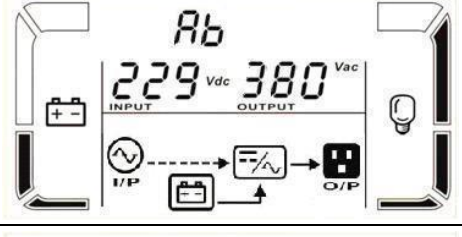
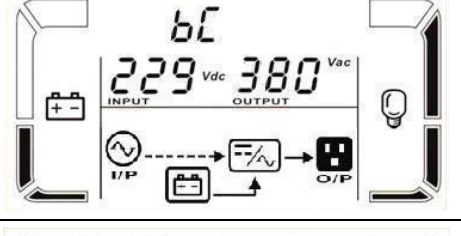
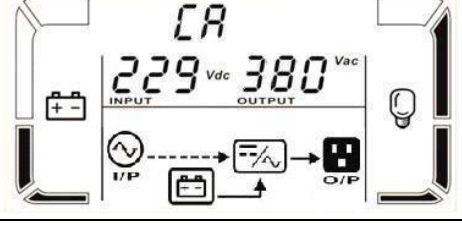
LCD display



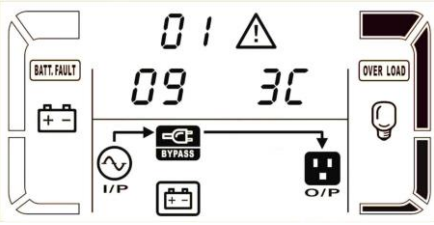

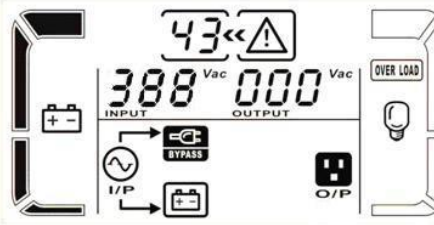



	
	
	

			
Battery mode	Description	When the input voltage/frequency is beyond the acceptable range or power failure, UPS will backup power from battery and alarm will beep every 4 seconds.	
	LCD display		
			
			
			
Bypass mode	Description	When input voltage is within acceptable range and bypass is enabled, turn off the UPS and it will enter Bypass mode. Alarm beeps every two minutes.	
	LCD display		
			

		 
		
Battery Test	Description	When UPS is in AC mode or CVCF mode, press "Test" key for more than 0.5s. Then, the UPS will beep once and start "Battery Test". The line between I/P and inverter icons will blink to remind users. This operation is used to check the battery status.
	LCD display	 
		 
		 
		
Warning status	Description	If some errors occur in the UPS (but it is still running normally), it will show one more screen to represent the warning situation. In the warning screen, the icon  will be flashing, and it can show up to 3 error codes and each code indicates one error. You can find the code meaning in the warning code table.

















	LCD display		
Fault status	Description	When UPS has fault happened, the inverter will be blocked. It will display fault code in screen, and the icon  will light up. You can find the code meaning in the fault code table.	
	LCD display		
			

3-9. Fault Code

Fault code	Fault event	Icon	Fault code	Fault event	Icon
01	Bus start failure	None	42	DSP communication failure	None
02	Bus over	None	43	Overload	
03	Bus under	None	46	Incorrect UPS setting	None
04	Bus unbalance	None	47	MCU communication failure	None
06	Converter over current	None	48	Two DSP firmware versions are incompatible in parallel system.	None
11	Inverter soft start failure	None	60	Bypass phase short circuited	
12	High inverter voltage	None	61	Bypass SCR short circuited	None
15	Inverter B output(line to neutral) short circuited		62	Bypass SCR open circuited	None
16	Inverter C output(line to neutral) short circuited		63	Voltage waveform abnormal in R phase	None
17	Inverter A-B output (line to line) short circuited		64	Voltage waveform abnormal in S phase	None
18	Inverter B-C output (line to line) short circuited		65	Voltage waveform abnormal in T phase	None
19	Inverter C-A output (line to line) short circuited		66	Inverter current sample abnormal	None
1A	Inverter A negative power fault	None	67	Bypass O/P short circuited	
1B	Inverter B negative power fault	None	68	Bypass O/P line to line short circuited	
1C	Inverter C negative power fault	None	69	Inverter SCR short circuited	None
21	Battery SCR short circuited	None	6C	BUS voltage drops too fast	None
23	Inverter relay open circuited	None	6D	Current sampling error value	None
24	Inverter relay short	None	6E	SPS power error	None

	circuited				
25	Line wiring fault	None	6F	Battery polarity reverse	None
31	Parallel communication failure	None	71	PFC IGBT over-current in R phase	None
32	The host signal failure	None	72	PFC IGBT over-current in S phase	None
33	Synchronous signal failure	None	73	PFC IGBT over-current in T phase	None
34	Synchronous trigger signal failure	None	74	INV IGBT over-current in R phase	None
35	Parallel communication loss	None	75	INV IGBT over-current in S phase	None
36	Parallel output current unbalance	None	76	INV IGBT over-current in T phase	None
41	Over temperature	None	78	LCD & MCU communication failure	None

3-10.Warning Indicator





Warning	Icon (flashing)	Alarm
Battery low	 	Beeping every second
Overload	 	Beeping twice every second
Battery unconnected	 	Beeping every second
Over charge	 	Beeping every second
EPO enable	 	Beeping every second
Fan failure/Over temperature	 	Beeping every second
Charger failure	 	Beeping every second
I/P fuse broken	 	Beeping every second
Other warnings(refer to 3-11)		Beeping every second

3-11.Warning Code

Warning code	Warning event	Warning code	Warning event
01	Battery unconnected	21	Line situations are different in parallel system
02	IP Neutral loss	22	Bypass situations are different in parallel system
04	IP phase abnormal	33	Locked in bypass after overload 3 times in 30 minutes
05	Bypass phase abnormal	34	Converter current unbalanced
07	Over charge	3A	Cover of maintain switch is open
08	Low battery	3C	Utility extremely unbalanced
09	Overload	3D	Bypass is unstable
0A	Fan failure	3E	Battery voltage too high
0B	EPO enable	3F	Battery voltage unbalanced
0D	Over temperature	40	Charger short circuited
0E	Charger failure		

4. Trouble Shooting

If the UPS system does not operate correctly, please solve the problem by using the table below.

Symptom	Possible cause	Remedy
No indication and alarm in the front display panel even though the mains is normal.	The AC input power is not connected well.	Check if input cable firmly connected to the mains.
The icon  and the warning code EP flash on LCD display and alarm beeps every second.	EPO function is activated. At this time, the EPO switch is in "OFF" status or the jumper is open.	Set the circuit in closed position to disable the EPO function.
The icon  and BATT. FAULT flash on LCD display and alarm beeps every second.	The external or internal battery is incorrectly connected.	Check if all batteries are connected well.
The icon  and OVER LOAD flash on LCD display and alarm beeps twice every second.	UPS is overload.	Remove excess loads from UPS output.
	UPS is overloaded. Devices connected to the UPS are fed directly by the electrical network via the Bypass.	Remove excess loads from UPS output.
	After repetitive overloads, the UPS is locked in the Bypass mode. Connected devices are fed directly by the mains.	Remove excess loads from UPS output first. Then shut down the UPS and restart it.
Fault code is shown as 43. The icon OVER LOAD lights on LCD display and alarm beeps continuously.	UPS is overload too long and becomes fault. Then UPS shut down automatically.	Remove excess loads from UPS output and restart it.
Fault code is shown as 14, 15, 16, 17, 18 or 19, the icon SHORT lights on LCD display, and alarm beeps continuously.	The UPS shut down automatically because short circuit occurs on the UPS output.	Check output wiring and if connected devices are in short circuit status.
Other fault codes are shown on LCD display and alarm beeps continuously.	A UPS internal fault has occurred.	Contact your dealer
Battery backup time is shorter than nominal value	Batteries are not fully charged.	Charge the batteries for at least 7 hours and then check capacity. If the problem still persists, consult your dealer.
	Batteries defect	Contact your dealer to replace the battery.
The icon  and  flash on LCD display and alarm beeps every second.	Fan is locked or not working. Or the UPS temperature is too high.	Check fans and notify dealer.

Symptom	Possible cause	Remedy
<p>The warning code 02 and the icon  flash on LCD display. The alarm beeps every second.</p>	<p>The input neutral wire is disconnected.</p>	<p>Check and correct the input neutral connection. If the connection is ok and the warning is still displaying, please refer to the LCD setting section, to enter the neutral loss check menu, to see if the parameter3 is "CHE". If it is, please press the "Enter" key firstly to make the "CHE" flash and press the "Enter" key secondly to make the UPS clear the alarm. If the warning still exists, please check input fuses of L2 and L3.</p>
	<p>The L2 or L3 input fuse is broken.</p>	<p>Replace the fuse.</p>

5. Storage and Maintenance

5-1. Storage

Before storing, charge the UPS at least 7 hours. Store the UPS covered and upright in a cool, dry location. During storage, recharge the battery in accordance with the following table:

Storage Temperature	Recharge Frequency	Charging Duration
-25°C - 40°C	Every 3 months	1-2 hours
40°C - 45°C	Every 2 months	1-2 hours

5-2. Maintenance

 The UPS system operates with hazardous voltages. Repairs may be carried out only by qualified maintenance personnel.

 Even after the unit is disconnected from the mains, components inside the UPS system are still connected to the battery packs which are potentially dangerous.

 Before carrying out any kind of service and/or maintenance, disconnect the batteries and verify that no current is present and no hazardous voltage exists in the terminals of high capability capacitor such as BUS-capacitors.

 Only persons are adequately familiar with batteries and with the required precautionary measures may replace batteries and supervise operations. Unauthorized persons must be kept well away from the batteries.

 Verify that no voltage between the battery terminals and the ground is present before maintenance or repair. In this product, the battery circuit is not isolated from the input voltage. Hazardous voltages may occur between the battery terminals and the grounding/earthing.

 Batteries may cause electric shock and have a high short-circuit current. Please remove all wristwatches, rings and other conductive objects before maintenance or repair, and only use tools with insulated grips and handles for maintaining or repairing.

 When replace the batteries, install the same number and same type of batteries.

 Do not attempt to dispose of batteries by burning them. This could cause battery explosion. The batteries must be deposited according to local environmental regulations.

 Do not open or destroy batteries. Escaping electrolyte can cause injury to the skin and eyes. It may be toxic.

 Please replace the fuse only with the same type and amperage in order to avoid fire hazards.

 Do not disassemble the UPS system.

6. Specifications

400V

MODEL	10K(L) 10K(L) DUAL	15K(L) 15K(L) DUAL 20K(L) 20K(L) DUAL	30K(L) 30K(L) DUAL	40K(L) 40K(L) DUAL	60KL 60KL DUAL	80KL 80KL DUAL	
CAPACITY*	10KVA / 10KW	15KVA / 15KW 20KVA / 20KW	30KVA / 30KW	40KVA / 40KW	60KVA / 60KW	80KVA / 80KW	
INPUT							
Voltage Range	Low Line Loss	110 VAC(Ph-N) \pm 3 % at 50% Load; 176 VAC(Ph-N) \pm 3 % at 100% Load					
	Low Line Comeback	Low Line Loss Voltage + 10V					
	High Line Loss	300 VAC(L-N) \pm 3 % at 50% Load; 276 VAC(L-N) \pm 3 % at 100% Load					
	High Line Comeback	High Line Loss Voltage - 10V					
Frequency Range	46Hz ~ 54 Hz @ 50Hz system 56Hz ~ 64 Hz @ 60Hz system						
Phase	3 Phase with Neutral						
Power Factor	\geq 0.99 at 100% Load						
OUTPUT							
Phase	3 Phase with Neutral						
Output voltage	360/380/400/415VAC (Ph-Ph)						
	208*/220/230/240VAC (Ph-N)						
AC Voltage Regulation	\pm 1%						
Frequency Range (Synchronized Range)	46Hz ~ 54 Hz @ 50Hz system; 56Hz ~ 64 Hz @ 60Hz system						
Frequency Range (Batt. Mode)	50 Hz \pm 0.1 Hz or 60Hz \pm 0.1 Hz						
Overload	AC mode	100%~110%: 60min; 110%~125%: 10min; 125%~150%:1min;>150% : immediately					
	Battery mode	100%~110%: 60min; 110%~125%: 10min; 125%~150%:1min;>150% : immediately					
Current Crest Ratio	3:1 max						
Harmonic Distortion	\leq 2 % @ 100% Linear Load; \leq 5 % @ 100% Non-linear Load						
Transfer Time	Line \leftarrow \rightarrow Battery	0 ms					
	Inverter \leftarrow \rightarrow Bypass	0 ms (When phase lock fails, <4ms interruption occurs from inverter to bypass)					
	Inverter \leftarrow \rightarrow ECO	<10 ms					
EFFICIENCY							
AC mode	95.5%						
Battery Mode	94.5%						
BATTERY							
Standard Model	Type	12 V / 9 Ah	12 V / 9 Ah	12 V / 7 Ah	12 V / 9 Ah	N/A	
	Numbers	(10+10)pcs	(16+16)pcs	(16+16)pcs x 2 strings			
	Recharge Time	9 hours recover to 90% capacity					
	Charging Current (max)	2.0 A \pm 10% (Recommended) 1.0~12.0A (Adjustable)					
	Charging Voltage	+/-136.5 VDC \pm 10%	+/-218 VDC \pm 10%				
Long-run Model	Type	Depending on applications					
	Numbers	(10+10) pcs	(16+16) ~ (20+20) pcs (Adjustable)				
	Charging Current(max.)	1.0~12.0A \pm 10% (Adjustable)				2.0~24.0A \pm 10% (Adjustable)	
	Charging Voltage	+/-136.5 VDC \pm 10%	+/- 13.65 VDC * N \pm 1% (N = 16~20)				
PHYSICAL							
Standard Model	Dimension, D X W X H (mm)	630 x 250 x 826		815 x 300 x 1000		N/A	
	Net Weight (kgs)	124/126	139/141	225/230	250/260		
Long-run Model	Dimension, D X W X H mm	630 x 250 x 826		815 x 300 x 1000		790 x 360 x 1010	
	Net Weight (kgs)	28/30	43/45	60/65	67/71	108/112 113/117	
ENVIRONMENT							
Operation Temperature	0 ~ 40°C (the battery life will down when > 25°C)						
Operation Humidity	<95 % and non-condensing						
Operation Altitude**	<1000m**						
Acoustic Noise Level	Less than 55dB @ 1 Meter	Less than 58dB @ 1 Meter	Less than 65dB @1 Meter	Less than 70dB @ 1 Meter	Less than 70dB @ 1 Meter	Less than 75dB @ 1 Meter	
MANAGEMENT							
Smart RS-232 or USB	Supports Windows® 2000/2003/XP/Vista/2008/7/8/10, Linux, Unix, and MAC						
Optional SNMP	Power management from SNMP manager and web browser						

* Derate capacity to to 90% when the output voltage is adjusted to 208VAC.

**If the UPS is installed or used in a place where the altitude is above than 1000m, the output power must be derated 1% per 100m.

***Product specifications are subject to change without further notice.

208V

MODEL		10K(L)	15K(L) 15K(L) DUAL	20K(L) 20K(L) DUAL	30KL 30KL DUAL	40KL 30KL DUAL	
CAPACITY*		10KVA /10KW	15KVA / 15KW	20KVA / 20KW	30KVA / 30KW	40KVA / 40KW	
INPUT							
Voltage Range	Low Line Loss	70 VAC(Ph-N) ± 3 % at 50% Load 88 VAC(Ph-N) ± 3 % at 100% Load					
	Low Line Comeback	Low Line Loss Voltage + 5V					
	High Line Loss	156 VAC(L-N) ± 3 % at 50% Load 146 VAC(L-N) ± 3 % at 100% Load					
	High Line Comeback	High Line Loss Voltage - 5V					
Frequency Range		46Hz ~ 54 Hz @ 50Hz system 56Hz ~ 64 Hz @ 60Hz system					
Phase		3 Phase with Neutral					
Power Factor		≥ 0.99 at 100% Load					
OUTPUT							
Phase		3 Phase with Neutral					
Output voltage		208/220VAC (Ph-Ph) 120/127VAC (Ph-N)					
AC Voltage Regulation		± 1%					
Frequency Range (Synchronized Range)		46Hz ~ 54 Hz @ 50Hz system 56Hz ~ 64 Hz @ 60Hz system					
Frequency Range (Batt. Mode)		50 Hz ± 0.1 Hz or 60Hz ± 0.1 Hz					
Overload	AC mode	100%~110%: 60min; 110%~125%: 10min; 125%~150%:1min;>150% : immediately					
	Battery mode	100%~110%: 60min; 110%~125%: 10min; 125%~150%:1min;>150% : immediately					
Current Crest Ratio		3:1 max					
Harmonic Distortion		≦ 2 % @ 100% Linear Load; ≦ 4 % @ 100% Non-linear Load (PF≥0.8)					
Transfer Time	Line↔Battery	0 ms					
	Inverter↔Bypass	0 ms (When phase lock fails, <4ms interruption occurs from inverter to bypass)					
	Inverter↔ECO	<10 ms					
EFFICIENCY							
AC mode		93.5%					
Battery Mode		92.5%					
BATTERY							
Standard Model	Type	12 V / 9 Ah	12 V / 7 Ah	12 V / 9 Ah	N/A		
	Numbers	(8+8)pcs x 2 strings	(8+8)pcs x 4 strings				
	Recharge Time	9 hours recover to 90% capacity					
	Charging Current(max.)	1.0~12.0A±10% (Adjustable)					
	Charging Voltage	+/-109 VDC ± 1%					
Long-run Model	Type	Depending on applications					
	Numbers	16 ~ 20 (adjustable)					
	Charging Current(max.)	1.0~12.0A±10% (Adjustable)			2.0~24.0A±10% (Adjustable)		
	Charging Voltage	+/- 13.65 VDC * N ± 1% (N = 8~10)					
PHYSICAL							
Standard Model	Dimension, D X W X H mm	630 x 250 x 826	815 x 300 x 1000	815 x 300 x 1000	N/A		
	Net Weight (kgs)	139/141	152	117			
Long-run Model	Dimension, D X W X H mm	630 x 250 x 826	815 x 300 x 1000	815 x 300 x 1000	790 x 360 x 1010	790 x 360 x 1010	
	Net Weight (kgs)	43/45	60/65	67/71	108/112	113/117	
ENVIRONMENT							
Operation Temperature		0 ~ 40°C (the battery life will down when > 25°C)					
Operation Humidity		<95 % and non-condensing					
Operation Altitude**		<1000m**					
Acoustic Noise Level		Less than 58dB @ 1 Meter	Less than 65dB @ 1 Meter	Less than 70dB @ 1 Meter	Less than 70dB @ 1 Meter	Less than 75dB @ 1 Meter	
MANAGEMENT							
Smart RS-232 or USB		Supports Windows® 2000/2003/XP/Vista/2008/7/8/10, Linux, Unix, and MAC					
Optional SNMP		Power management from SNMP manager and web browser					

* If the UPS is installed or used in a place where the altitude is above than 1000m, the output power must be derated 1% per 100m.

**Product specifications are subject to change without further notice.